

Grove RT880E

Product Guide

 75 t

 39 m

 10,0 - 29,2 m

 71 m



**Rough Terrain Crane • Geländekran
Grue Tout-Terrain • Grúa Todo Terreno
Autogru Fuoristrada • Grua RT**

Кран для использования на пересеченной местности

Features • Besonderheiten • Caractéristiques • Carasterísticas Caratteristiche • Carasterísticas • Особенности



- **BOOM:** the Grove MEGAFORM boom shape eliminates weight and increases capacity compared to conventional shapes.
- **AUSLEGER:** Der MEGAFORM-Ausleger von Grove spart im Vergleich zu herkömmlichen Ausführungen Gewicht und erhöht die Tragfähigkeit.
- **FLECHE :** le design megaform de la flèche rend la grue plus légère et augmente ses capacités de levage par rapport aux flèches conventionnelles.
- **PLUMA:** con forma Grove MEGAFORM reduce el peso y aumenta la capacidad en comparación con las formas de pluma convencionales.
- **BRACCIO:** la forma del braccio Grove MEGAFORM riduce il peso e aumenta la portata rispetto alle forme convenzionali.
- **LANÇA:** a forma MEGAFORM da lança da Grove proporciona uma redução do peso e um aumento da capacidade face às formas convencionais.
- **СТРЕЛА:** по сравнению со стрелами обычной формы, форма стрелы Grove MEGAFORM имеет меньший вес и повышает грузоподъемность.

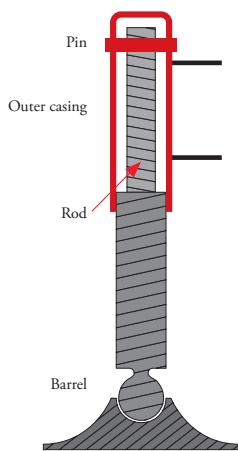

- **INVERTED OUTRIGGERS JACKS:** allows to protect the cylinder rod from sand, dust, oils and various element you can find on a jobsite. The outriggers can be fixed in 3 different positions: fully retracted, 50 % and 100 %.
- **INNEN LIEGENDE ABSTÜTZZYLINDER:** schützt die Zylinderstange vor Sand, Staub, Öl und verschiedenen anderen Einflüssen auf der Baustelle. Die Abstützträger können in 3 Stellungen fixiert werden: Voll eingefahren, 50 % und 100 %.
- **SYSTÈME DE CALAGE INVERSÉ :** permet de protéger la tige de vérin du sable, de la poussière, de la graisse et de tout autre élément courant sur un site de chantier. Le système de calage peut être placé dans 3 positions : entièrement rentré, 50 % et 100 %.
- **ESTABILIZADORES INVERTIDOS:** permite proteger el vástago del cilindro, de la arena, el polvo, aceites y diversos elementos que se pueden encontrar en el lugar de trabajo. Los estabilizadores se pueden fijar en 3 posiciones diferentes: Totalmente plegados, 50% y 100%.
- **STABILIZZATORI A STELI ROVESCIATI:** consentono di proteggere lo stelo del cilindro da sabbia, polvere, olio e vari elementi che si trovano sui luoghi di lavoro. Gli stabilizzatori possono essere estesi in 3 posizioni diverse: Completamente retratti, 50% e 100%.
- **ESTABILIZADORES INVERTIDOS:** permite proteger a haste do cilindro da areia, do pó, dos óleos e dos vários elementos que se podem encontrar num local de trabalho. Os estabilizadores podem ser fixados em 3 posições diferentes: totalmente fechados, abertos a 50% e abertos a 100%.
- **ПЕРЕВЕРНУТЫЕ ЦИЛИНДРЫ ОПОР:** способствуют защите штока цилиндра от попадания песка, пыли и прочих веществ, имеющихся на рабочем месте. Выносные опоры можно устанавливать в 3 различных положениях: выдвинув полностью, на 50% или 100%.



- **MAINTENANCE:** hydraulic valves in one convenient, easy to access location.
- **WARTUNG:** leicht zugängige Halteventile erleichtern den Zugang bei Wartungsarbeiten.
- **MAINTENANCE :** un seul compensateur de pression monté sur l'extérieur, pour un accès facile lors de la maintenance.
- **MANTENIMIENTO:** válvulas de presión de una única ubicación exterior montadas para facilitar el acceso en el mantenimiento.
- **MANUTENZIONE:** tutte le valvole sono state positionate in modo semplice ed ordinato con facile accessibilità.
- **MANUTENÇÃO:** os conjuntos de válvulas estão montados num único local, no exterior, para possibilitar um acesso mais fácil para efeitos de manutenção.
- **ОБСЛУЖИВАНИЕ:** гидроклапаны расположены в удобном для обслуживания месте.

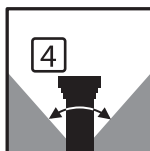
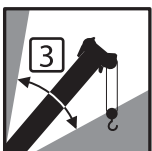
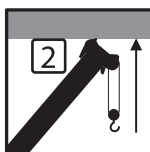

- **WORK AREA DEFINITION SYSTEM:** the system creates "virtual walls" that will alert the operator when approaching the limits of the pre-set working area.
- **ARBEITSBEREICHSBEGRENZER:** das System erstellt «virtuelle Wände». Der Bediener wird gewarnt, sobald er sich den Grenzen des vordefinierten Arbeitsbereichs nähert.
- **DISPOSITIF DE LIMITATION DU DOMAINE D'ÉVOLUTION (Work Area Definition System) :** ce système crée des « parois virtuelles » et alerte l'opérateur lorsque la grue s'approche des limites de la zone d'évolution prédéfinie.
- **SISTEMA DE DEFINICIÓN DE ÁREA DE TRABAJO:** este sistema crea «muros virtuales» que alertarán al operador cuando se acerque a los límites del área de trabajo predefinida.
- **SISTEMA DI DEFINIZIONE DELL'AREA DI LAVORO:** l'operatore crea dei "muri virtuali" e sarà avvisato all'avvicinarsi dei limiti dell'area di lavoro predefinita.
- **SISTEMA DE DEFINIÇÃO DA ÁREA DE TRABALHO:** o sistema cria «paredes virtuais» que, quando a grua se está a aproximar dos limites predefinidos para a área de trabalho, fazem com que o operador seja avisado em conformidade.
- **СИСТЕМА ОГРАНИЧЕНИЯ РАБОЧЕЙ ЗОНЫ:** система создает «виртуальные стены», предупреждающие оператора о приближении к границам заданной рабочей зоны.

Contents • Inhalt • Contenu • Contenido Contenuto • Índice • Содержание

Features • Besonderheiten • Caractéristiques • Caratteristiche	
Características • Características • Осоюенности	2
Specification	4
Technische Daten	5
Caractéristiques techniques	6
Características	7
Caratteristiche tecniche	8
Características técnicas	9
Технические характеристики	10
Data • Daten • Caractéristiques • Datos • Dati • Características • Данные	11
Dimensions • Abmessungen • Encombremet • Dimensiones • Dimensioni • Dimensões • Размеры	12
Load charts • Traglasten • Capacités de levage • Capacidades • Capacità • Diagramas de carga	
Таблицы грузоподъемности	
Notes • Hinweise • Notes • Notas • Note • Notas • Примечания	13
Working Range • Arbeitsbereiche • Diagramme de levage • Gama de trabajo • Area di lavoro • Area de trabalho	
Грузовысотные характеристики	14
Telescopic Boom • Teleskopausleger • Flèche principale • Pluma telescópica • Braccio telescopico	
Lança telescópica • Телескопическая стрела	15
Swingaway • Klappspitze • Extension treillis • Plumín • Jib • Swingaway • Откидной удлинитель стрелы	19
Weight reductions • Gewichte der Lastaufnahmemittel • Reductions de charge	
Reducciones de peso • Riduzioni di peso • Reduções de peso • Снижение веса	21
Symbols • Symbolerklärung • Glossaire des symboles • Glosario de símbolos • Glossario dei simboli • Símbolos	
СИМВОЛЫ	23



Manitowoc Crane Care is the Manitowoc's unparalleled product support organisation. Maniowoc Crane Care combines all aspects of parts, service, technical documentation, technical support and training into one organisation. The program includes all of the Manitowoc's brands, which include, Potain, Grove, Maniowoc and National Crane.

For the care of your crane and the prosperity of your business, Maniowoc Crane Care is your single source for customer support. Wherever, whenever, whatever – we're there.

Maniowoc Crane Care vereint alle Serviceleistungen von Maniowoc im Produktsupport vor und nach dem Verkauf: Ersatzteile, Service, technische Dokumentation, technischer Support und Schulung, alles unter einem Dach. Dieser Service erstreckt sich auf alle Marken von Maniowoc: Potain, Grove, Maniowoc und National Crane.

Damit Ihr Kran leistungsfähig bleibt und Ihr Erfolg gesichert ist, bietet Ihnen Maniowoc Crane Care einen umfassenden Support aus einer Hand. Zu jeder Zeit, an jedem Ort, für jeden Fall – wir sind für Sie da.

Organisation hors pair dédiée au support technique des produits de Maniowoc, Maniowoc Crane Care réunit au sein d'une même entité tous les aspects du service : pièces de rechange, service après-vente, publication technique, assistance technique et formation. Ce programme s'adresse à toutes les marques de Maniowoc : Potain, Grove, Maniowoc et National Crane.

Pour assurer l'entretien de vos grues et la prospérité de votre entreprise, Maniowoc Crane Care constitue votre unique interlocuteur du service à la clientèle. Où que vous soyez, quel que soit votre besoin, vous pouvez toujours compter sur nous !

Maniowoc Crane Care, es la organización post-venta y soporte técnico de Maniowoc. Maniowoc Crane Care combina todos los aspectos de piezas de repuesto, servicio, documentación técnica, apoyo técnico y formación en un único lugar. El programa también incluye todas las ramas Maniowoc que engloba Potain, Grove, Maniowoc y National Crane.

Para el cuidado de su grúa y la prosperidad de su negocio, Maniowoc Crane Care, es la forma más sencilla de ayudarle. Donde sea y cuando sea, nosotros estamos allí.

Maniowoc Crane Care è l'ineguagliabile organizzazione di supporto di Maniowoc. Maniowoc Crane Care gestisce tutte le attività legate a pezzi di ricambio, documentazione tecnica, assistenza tecnica e formazione riunite in un unico punto di riferimento. Questo servizio è attivo per tutti i marchi di Maniowoc e precisamente Potain, Grove, Maniowoc e National Crane.

Per l'assistenza delle Vostre gru e per la redditività dei Vostri investimenti, Maniowoc Crane Care è l'insostituibile Vostra risorsa. In ogni posto, tutte le volte, per qualsiasi necessità – noi ci siamo.

Organização verdadeiramente ímpar do Maniowoc Crane Group, é à Maniowoc Crane Care que compete a responsabilidade pelo suporte técnico dos nossos produtos. Ela reúne, numa mesma entidade, todos os aspectos do serviço: peças de substituição, serviço pós-venda, documentação técnica, suporte técnico e formação. Este programa abrange todas as marcas do Maniowoc Crane Group: Potain, Grove, Maniowoc e National Crane.

Para assegurar a manutenção cuidada das suas gruas e a prosperidade do seu negócio, o seu único interlocutor do serviço de clientes é a Maniowoc Crane CARE. Esteja onde estiver, sejam as horas que forem, precise do que precisar, pode sempre contar connosco!

Maniowoc Crane Care - это не имеющая аналогов организация, входящая в Maniowoc и осуществляющая техническую поддержку продукции. Maniowoc Crane Care занимается всеми аспектами, связанными с запасными частями, услугами, технической документацией, технической поддержкой и обучением. Программа включает все торговые марки Maniowoc, в том числе, Potain, Grove, Maniowoc и National Crane.

Maniowoc Crane Care является единой точкой контактов для всех клиентов компании, где они могут получить полное обслуживание для используемых ими кранов, что, в свою очередь, обеспечит процветание их бизнеса. Мы всегда там и в тот момент, где и когда мы необходимы.

Specification

Superstructure



Boom

12,6 m – 39,0 m, four-section, sequenced synchronized full power boom.
Maximum tip height: 41,9 m.



*Bifold swingaway extension

10,0 m - 17,1 m offsettable bifold lattice swingaway extension. Offsets 0°, 20° and 40°. Stows alongside base boom section.
Maximum tip height: 58,6 m.



*Telescopic Swingaway extension

2 x 6,1 m lattice extension inserts. Installs between the boom nose and bifold extension, non-stowable. Maximum tip height: 70,6 m.



Boom elevation

One double acting hydraulic cylinder with integral holding valve provides elevation from -3° to +78°.



Load moment and anti-two block system

Standard “Graphic Display” load moment and anti-two block system with audio-visual warning and control lever lockout. These systems provide electronic display of boom angle, length, radius, tip height, relative load moment, maximum permissible load, load indication and warning of impending two-block condition. The standard Work Area Definition System allows the operator to pre-select and define safe working areas. If the crane approaches the pre-set limits, audio-visual warnings aid the operator in avoiding job-site obstructions.



Cab

Full-vision, all-steel fabricated with acoustical lining and tinted safety glass throughout. Cab tilts to +20 degrees. Deluxe seat incorporates armrest-mounted hydraulic single-axis controllers. Dash panel incorporates gauges for all engine functions. Other standard features include: hot water heater, cab circulating air fan, sliding side and rear windows, sliding skylight with electric wiper and sunscreen, electric windshield wash/wipe, fire extinguisher and seat belt. AC.



Slewing

Two speed, planetary swing drive with foot applied multi-disc wet brake. Spring applied, hydraulically released swing brake. Single position mechanical house lock, operated from cab. Maximum speed: 2,0 RPM.



Counterweight

8 165 kg. Hydraulically installed and removed.



Hydraulic system

Two main pumps ([1] piston and [1] gear) with a combined capacity of 503 LPM. Maximum operating pressure: 277,7 bar. Three section pressure compensated valve bank. Return line type filter with full flow by-pass protection and service indicator. Replaceable cartridge with micron filtration rating of 5/12/16. 995 L hyd. reservoir. Carrier mounted oil cooler with thermostatically controlled hydraulic motor driven fan/air to oil. System pressure test ports.



Hoist

Planetary reduction with automatic spring applied multi-disc wet brake. Electronic hoist drum rotation indicators, and hoist drum cable followers.

Maximum Single Line Pull:

- 1st layer: 9 185 kg. • 3rd layer: 7 716 kg.
- 5th layer: 6 650 kg.

Maximum Permissible Line Pull: 7 620 kg with 6X37 class rope.

7 620 kg. with 35X7 Rotation Resistant rope.

Maximum Single Line Speed: 156 m/min.

Rope Construction: 6X36 EIPS IWRC, Special Flexible
35x7 Flex-X, Rotation Resistant

Rope Diameter: 19mm.

Rope Length: Main Hoist: 183 m - Auxiliary Hoist: 183 m.

Maximum Rope Stowage: 256 m.

Carrier



Carrier frame

Box section frame fabricated from high-strength, low alloy steel.
Front/rear towing and tie down lugs.



Outriggers

Four hydraulic telescoping single-stage double box beam outriggers with inverted jacks and integral holding valves. Three position setting, 0%, 50% and fully extended. All steel fabricated, quick release type outrigger floats, 775 mm diameter. Maximum outrigger pad load: 56 700 kg.
Controls and crane level indicator located in cab.



Engine

Cummins QSB 6,7L diesel, six cylinders, 275 bhp, 205 kW (Gross) at 2 500 RPM. Maximum torque: 987 Nm at 1 500 RPM.



Transmission

Sequential powershift with 6 forward and 6 reverse speeds.
Front axle disconnect for 4 x 2 travel.



Drive/Steer

4 x 4.

Fully independent power steering:

Front: Full hydraulic steering wheel controlled.

Rear: Full hydraulic switch controlled.

Provides infinite variations of 4 main steering modes: front only, rear only, crab and coordinated. Rear steer indicator. Turning radius: 7,5 m.



Axles

Front: Drive/steer with differential and planetary reduction hubs rigid mounted to frame.

Rear: Drive/steer with differential and planetary reduction hubs pivot mounted to frame.



Tyres

29,5 x 25 - 34 bias ply.



Brakes

Full hydraulic split circuit operating on all wheels. Spring-applied, hydraulically released parking brake mounted on front axle.



Lights

Full lighting including turn indicators, head, tail, brake and hazard warning lights.



Maximum speed

35 km/h.



Gradeability (theoretical)

75 % based on 49 060 kg GVW, 29,5 x 25 tyres, 39,0 m boom, plus 17,1 swingaway, 8165 kg counterweight, 75 t hookblock and 9 t headache ball.



Electrical system

Two 12 V - maintenance free batteries. 12 V starting and lighting.
Battery disconnect. CanBus Diagnostic system.

* Optional equipment

- CE Mark conformance
- Auxiliary lighting package (includes cab mounted amber flashing light, hoist mounted work light, and dual base boom mounted floodlights).
- LMI light bar (in cab).
- 360° NYC style mechanical swing lock.
- Rear Pintle hook.
- Cab controlled cross axle differential locks, (front and rear).
- PAT data logger.
- Rubber mat for storage trough.

*Denotes optional equipment

Kranoberwagen



Ausleger

Von 12,6 m bis 39,0 m ausfahrbarer, vierteiliger, voll teleskopierbarer Ausleger mit Synchronverstellung. Maximale Rollenhöhe 41,9 m.



*Doppelklappspitze

Abwinkelbare Doppel-Klappspitze in Gitterbauweise, 10,0 - 17,1 m. Abwinkelbar 0°, 20°, 40°, an den Teleskop-Grundausleger anklappbar. Maximale Arbeitshöhe : 58,6 m.



*Teleskopklappspitze

Zwei (2) Zwischenstücke in Gitterbauweise, jeweils 6,1 m lang. Anbau zwischen Auslegerkopf und Doppel-Klappspitze, nicht verstaubar. Maximale Rollenhöhe: 70,6 m.



Wippwerk

Ein doppelt wirkender Hydraulikzylinder mit integriertem Sicherheits-Rückschlagventil. Auslegerstellwinkel von -3° bis +78°.



Lastmoment- und Hubendschalter-System

System für Lastmomentbegrenzung über Standard-„Grafikdisplay“ und Anti-Two Block System mit akustisch-optischer Warnung und Steuerhebelsperre. Diese Systeme bieten elektronische Anzeige von Auslegerwinkel, Auslegerlänge, Radius, Arbeitshöhe, relativem Lastmoment, maximal zulässiger Last, Hakenlast und Hubendschaltungs-Vorrichtung. Das zur Standardausrüstung gehörende System zur Arbeitsbereichsbegrenzung ermöglicht es dem Bediener, sichere Arbeitsbereiche vorzugeben und zu definieren. Nähert sich der Kran der Begrenzung des sicheren Arbeitsbereichs, wird der Bediener akustisch und optisch gewarnt, wodurch Kollisionen am Einsatzort vermieden werden.



Kabine

Rundsichtkabine, in Stahlblech ausgeführt, mit Schalldämmung und getöntem Sicherheitsglas. Kabine lässt sich um +20 Grad neigen. Komfortsitz mit in die Armlehnen integrierten, einachsigen verstellbaren Steuerhebeln. Armaturenbrett mit Anzeigen für alle Motorfunktionen. Weitere Standardausrüstung: Heißwasserheizung, Umluftgebläse, Schiebefenster seitlich und hinten, Dachschiebefenster mit elektrischem Scheibenwischer und Sonnenschutz, elektrischer Frontscheibenwischer/Waschanlage, Feuerlöscher und Sicherheitsgurt. AC.



Schwenkwerk

Zweistufiges Planetenschwenkwerk mit fußbetätigter Mehrscheiben-Ölbadbremse. Hydraulisch lösbare Federspeicher-Feststellbremse. Von der Kabine aus in einer Stellung festsetzbare Bolzenverriegelung. Max. Drehgeschwindigkeit: 2,0 RPM.



Gegengewicht

Gegengewicht 8 165 kg, hydraulisch an- und abbaubar.



Hydrauliksystem

Zwei Hauptpumpen ([1] Kolben- und [1] Zahnradpumpe), Gesamtfördermenge 503 l/Min. Maximaler Betriebsdruck: 277,7 bar. Druckkompensierter Ventilblock in drei Abschnitten. Filter mit Vollstrom-Bypassschutz und Wartungsanzeige im Rücklauf. Wechsellpatrone mit einer Filtrierleistung von 5/12/16 Mikron. Fassungsvermögen des Hydrauliköltanks : 995 Liter. Am Chassis angebaute Ölkühler mit thermostatisch geregelter, vom Hydraulikmotor angetriebenem Lüfter/Luft-zu-Öl. Systemdruck-Prüfanschlüsse.



Hubwerk

Planetengetriebe mit automatischer Federspeicher-Mehrscheibenbremse im Ölbad. Elektronischer Hubwerksumdrehungs-Melder sowie Seilführungsbügel. Maximaler Seilzug mit einfachem Strang:

- Erste Lage: 9 185 kg. • Dritte Lage: 7 716 kg.
- Fünfte Lage: 6 650 kg.

Maximal zulässiger Seilzug: 7 620 kg mit Seil Kategorie 6 x 37.

7 620 kg mit 35x7 Flex-X, drallfrei.

Maximale Seilgeschwindigkeit mit einfachem Strang: 156 m/Min.

Seilaufbau : 6X36 EIPS IWRC, besonders flexibel, 35x7 Flex-X, drallfrei.

Seildurchmesser: 19mm.

Seillänge: Haupthubwerk : 183 m. Hilfshubwerk : 183 m.

Hubwinde für max. 256 m Seil ausgelegt.

Kranunterwagen



Rahmen

Kastenprofilrahmen aus hochfestem Feinkornstahl. Abschlepp- und Verzurrösen vorne/hinten.



Abstützungen

Vier hydraulisch teleskopierbare, einteilige Kastenprofil-Abstützträger mit innen geführten Stützzyllindern und integrierten Halteventilen. Drei Stellungen: 0%, 50% und voll ausgefahren. Abstützteller mit Schnellentriegelung aus Stahl, Durchmesser 775 mm, maximaler Stützdruck per Teller 56 700 kg. Bedienelemente und Nivellieranzeige in der Kabine.



Motor

Cummins QSB 6,7 Liter Sechszylinder-Dieselmotor, 275 PS, 205 kW (brutto) bei 2 500 U/Min. Max. Drehmoment : 987 Nm bei 1 500 U/Min.



Getriebe

Sequenzielles Powershiftautomatikgetriebe, 6 Vorwärtsgänge und 6 Rückwärtsgänge.



Antrieb/Lenkung

4 x 4.

Separate Servolenkung :

Vorne : Vollhydraulisch, über Lenkrad betätigt.

Hinten : Vollhydraulisch, über Schalter betätigt.

Stellt vier stufenlos veränderliche Lenkartens bereit : Nur vorne, nur hinten, Hundegang und koordiniert. Lenkungsanzeige hinten. Wendekreis : 7,5 m.



Achslinien

Vorne: Antrieb/Lenkung über Differenzial und Planetenuntersetzungsgetriebe, fest mit dem Rahmen verbunden.

Hinten: Antrieb/Lenkung über Differenzial und Planetenuntersetzungsgetriebe, pendelnd mit dem Rahmen verbunden.



Bereifung

29,5 x 25 – 34-lagig, Diagonalreifen.



Bremsen

Vollhydraulische Bremsen mit geteilten Bremskreisen, auf alle Räder wirkend. Hydraulisch lösbare Federspeicher-Feststellbremse, auf die Vorderachse wirkend.



Beleuchtung

Volle Beleuchtungsanlage mit Blinkleuchten, Scheinwerfern, Schluss- und Bremsleuchten und Warnblinkanlage.



Höchstgeschwindigkeit

35 km/h.



Steigvermögen (theoretisch)

75 % (basierend auf: Bruttogewicht des Fahrzeugs 49 060 kg, Reifengröße 29,5 x 25, Ausleger 39,0 m plus Klappspitze 17,1 m, Gegengewicht 8.165 kg, Hakenflasche 75 t und Hakenschirr 9 t)



Elektrische Anlage

Zwei wartungsfreie 12-Volt-Batterien. 12-Volt-Starter und Beleuchtungsanlage. Batterie-Trennschalter. Diagnose über CAN-Datenbus.

* Zusatzausrüstung

- CE-Konformität.
- Zusatzbeleuchtungspaket (einschl. kabinenmontierte Rundumwarnleuchte [orange], hubwerksmontierte Arbeitsleuchte und zwei am Ausleger-Grundstück montierte Flutlichter).
- LMI Leuchtenleiste (in der Kabine)
- Mechanische Schwenkwerksverriegelung, 360 Grad, Typ NYC. • Abschleppöse hinten.
- Differenzialsperren (vorne und hinten), von der Kabine aus zuschaltbar.
- PAT Datalogger.
- Gummimatte für Staufach.

*Kennzeichnet wahlweise Zusatzausrüstung

Caractéristiques techniques

Superstructure



Flèche

12,6 m - 39,0 m. Flèche télescopique hydraulique à quatre éléments, séquentielle et synchronisée. Hauteur maximale de tête de flèche : 41,9 m.



*Extension treillis

Extension treillis à double repliage latéral de 10,0 à 17,1 m avec possibilité de déport à 0°, 20° et 30°. Hauteur max. de tête d'extension : 58,6 m.



*Éléments intermédiaires pour extension de treillis

2 éléments intermédiaires de 6,1 m pour extension treillis installés entre la tête de flèche principale et l'extension treillis double ; éléments transportés séparément. Hauteur max. d'extension treillis : 70,6 m.



Relevage

Un vérin hydraulique double effet avec clapet anti-retour intégré. Angles de relevage -3° à +78°.



Contrôleur d'état de charge et dispositif de fin de course haute crochet indépendant

En standard, contrôleur d'état de charge à affichage graphique et dispositif de course haute avec alarmes sonores et visuelles et dispositif de coupure des mouvements. Ces dispositifs donnent un affichage graphique de l'angle et de la longueur de flèche, de la portée, de la hauteur de tête de flèche, du moment relatif, de la charge maximum autorisée, de la charge levée et de sécurité de fin de course haute crochet. Le dispositif standard de limitation du domaine d'évolution (Work Area Definition System) permet à l'utilisateur de pré-définir et limiter le domaine de travail autorisé.



Cabine

Cabine panoramique tout acier avec isolation sonore et vitrages de sécurité teintés, inclinable à 20°. Siège ergonomique équipé de manipulateurs multidirectionnels électriques doubles-axes intégrés aux accoudoirs. Tableau de bord équipé de tous les instruments nécessaires à la surveillance du moteur. Autres équipements montés en standard : colonne de direction réglable en inclinaison, chauffage de cabine à eau chaude, ventilateur, vitrages coulissants latéraux et arrière, vitre de toit coulissante équipée d'un essuie-glace et d'un rideau pare-soleil, essuie-glace et lave-glace de pare-brise, extincteur et ceinture de sécurité. AC.



Orientation

Réducteur d'orientation à planétaires, frein multi-disques immergés à commande au pied. Frein de rotation à ressort à débrayage hydraulique. Verrouillage de sécurité mécanique à une position, actionné depuis la cabine. Vitesse maximale : 2 tpm.



Contrepoids

Contrepoids de 8 165 kg à mise en place et dépose hydraulique.



Système hydraulique

Deux pompes principales, une à pistons et une à engrenages, donnant un débit combiné de 503 litres/min. Pression maximum de service : 277,7 bars. Distributeur hydraulique trois éléments avec compensateurs de pression. Filtre hydraulique sur circuit de retour avec protection par dérivation plein débit et indicateur de colmatage. Cartouche amovible avec classe de filtration micrométrique 5/12/16. Réservoir hydraulique de 995 litres. Prises de pressions rapides.



Treuil

Entraînement par réducteur à planétaires et frein multi-disques immergés. Indicateurs électroniques de rotation du treuil et dispositif presse-câble. Efforts max. sur brin simple :

- 1^{ère} couche : 9 185 kg. • 3^e couche : 7 716 kg.
- 5^e couche : 6 650 kg.

Effort max. autorisé sur brin simple : 7 620 kg avec câble de classe 34x37.

Vitesse max. de déroulement : 156 m/min.

Câbles antigiratoires type 6 x 36 EIPS IWRC, Special Flexible ou 35x7 Flex-X.

Diamètre : 19 mm.

Longueur de câble : Treuil principal et auxiliaire 183 m.

Capacité maximum de câble : 256 m.

Châssis



Châssis

Châssis caissonné mécanosoudé en acier à haute limite élastique. Chapes de remorquage et d'arrimage à l'avant et à l'arrière.



Dispositif de calage

Quatre poutres de calage hydrauliques télescopiques avec vérins inversés et clapets anti-retour intégrés. Calage autorisé en trois positions : 0 – 50% et 100%.

Patins d'appui carrés (775 mm de diamètre) en acier avec dispositifs de fixation rapide. Charge maximum sur appui : 56 700 kg.

Commandes de calage et indicateur de niveau dans la cabine.



Moteur

Moteur Diesel 6 cylindres Cummins QSB 6,7L développant 275 Ch, 205 kW (brut) à 2 500 tours/min. Couple maximum : 987 Nm à 1 500 tours/min.



Boîte de vitesse

Boîte de vitesses séquentielle à 6 rapports avant et 6 rapports arrière.



Direction/transmission

4 x 4.

Direction hydraulique indépendante :

Avant : Direction hydraulique indépendante actionnée par volant.

Arrière : Direction hydraulique indépendante commandée par interrupteur au tableau de bord.

Combinaisons infinies des quatre modes de direction : avant uniquement, arrière uniquement, marche en crabe et mode coordonné. Indicateur de direction arrière. Rayon de braquage : 7,5 m.



Ponts

Avant : Pont moto-directeur avec différentiel et réductions à planétaires dans les moyeux fixé de manière rigide au châssis.

Arrière : Pont moto-directeur avec différentiel et réductions à planétaires dans les moyeux articulé au châssis.



Pneumatiques

Pneumatiques 29,5 x 25 à carcasse conventionnelle 34 plis.



Freins

Freinage sur toutes les roues avec circuit scindé. Frein de stationnement à serrage par ressorts et desserrage hydraulique sur l'essieu avant.



Eclairage

Eclairage complet incluant les clignotants, ainsi que les feux avant, arrière, de freinage et de détresse.



Vitesse maximum

35 km/h.



Aptitude (théorique) en pente

75 % pour un véhicule d'un poids total de 49 060 kg, équipé de pneus 29,5 x 25, d'une flèche de 39 m, d'une extension treillis à repliage latéral de 17,1 m, d'un contrepoids de 8 165 kg, d'un moufle de 75 t et d'un crochet simple leste de 9 t.



Installation électrique

Deux batteries sans entretien de 12 Volts pour l'éclairage et le démarrage. Coupe circuit. Système de diagnostique Can Bus.

* Equipements optionnels

- Conformité CE.
- Ensemble d'éclairage auxiliaire (inclut le girophare orange sur cabine, le feu de travail sur treuil et deux phares de travail montés à l'extrémité du caisson de base).
- Barrette d'affichage CEC (en cabine).
- Verrouillage mécanique d'orientation 360° (type "Ville de New York").
- Crochet de remorquage.
- Différentiels inter-roues commandés depuis la cabine (avant et arrière).
- Enregistreur de données PAT data logger.
- Tapis en caoutchouc pour le coffre de stockage.

*Équipements optionnels

Superestructura



Pluma

12,6 m – 39,0 m. Pluma de cuatro secciones, sincronizada y totalmente hidráulica. Altura máxima en punta al suelo : 41,9 m.



*Plumín de celosía

Plumín de celosía articulado en dos secciones de 10,0 m - 17,1 m. Angulable a 0°, 20° y 40°. Plegable junto al tramos base de la pluma. Altura máxima en punta: 58,6 m.



*Extensión de pluma de celosía

2 secciones de extensión de pluma de celosía de 6,1 m. Se instalan entre la cabeza de la pluma y el plumín de celosía, no se pueden plegar junto al tramo base de la pluma. Altura máxima en punta : 70,6 m.



Elevación de pluma

Un cilindro hidráulico de doble efecto con válvula de retención integrada logrando elevación entre -3° y +78°.



Sistema indicador del momento de carga y de final de carrera del gancho

Momento de carga estándar “con indicador gráfico” y sistema antibloqueo doble con señal de aviso sonora y visual y bloqueo de la palanca de control. Estos sistemas proporcionan la visualización en una pantalla electrónica del ángulo, longitud, radio, altura de la punta al suelo, momento de carga relativo, carga máxima admisible, indicación de carga y aviso del estado del bloqueo doble inminente de la pluma. El sistema de definición del área de trabajo estándar permite al operario preseleccionar y definir zonas de trabajo seguras. Si la grúa se acerca a los límites predefinidos, una señal de aviso sonora y visual ayuda al operario a evitar obstrucciones en el lugar de la obra.



Cabina

Cabina de visión panorámica, toda ella fabricada en acero con revestimiento acústico y cristal de seguridad tintado por completo. La cabina bascula hasta +20 grados. Asiento de lujo que incorpora los controles eléctricos de operación montados en reposabrazos. El panel de instrumentos incorpora indicadores para todas las funciones del motor. Forman parte del equipo de serie: volante regulable en altura, calefacción de agua, ventilador para la cabina, ventanillas laterales y traseras deslizantes, ventana superior abatible con limpia-parabrisas eléctrico y parasol, extintor y cinturón de seguridad. AC.



Rotación

Dos velocidades, giro deslizante mediante planetarios con freno de discos múltiples accionado por pedal. Freno de giro accionado mediante resorte con desconexión hidráulica. Bloqueo interno mecánico de una única posición accionado desde la cabina. Velocidad máxima: 2 rpm



Contrapeso

8 165 kg. Instalado y desmontado hidráulicamente.



Sistema hidráulico

Dos bombas principales (una de pistón y una de engranaje) con una capacidad combinada de 503 lpm. Presión de funcionamiento máxima: 277,7 bar. Banco de válvula de presión compensada de tres secciones. Filtro en la línea de retorno con protección by-pass de flujo e indicador de mantenimiento. Cartucho reemplazable con una tasa de microfiltrado de 5/12/16. Depósito de aceite hidráulico de 995 l. Puertos de prueba de presión del sistema.



Especificaciones del mecanismo de elevación principal y auxiliar

Reducción planetaria con freno automático de discos múltiples aplicado mediante resorte. Tambor acanalado con indicadores electrónicos de rotación del tambor. Tensión máxima de un solo ramal de cable:

- Primera capa: 9 185 kg.
- Tercera capa: 7 716 kg.
- Quinta capa: 6 650 kg.

Tracción máxima admisible del cable: 7 620 kg con cable de clase 34x37.
7 620 kg con cable 35 x 7 antirrotación.

Velocidad máxima de un solo cable: 156 m/min
Estructura del cable : 6x36 EIPS IWRC, flexible especial
35x7 Flex-X, antirrotación.

Diámetro del cable : 19 mm.
Longitud del cable : Cabrestante principal y auxiliar : 183 m
Capacidad máxima de cable en el tambor : 256 m

Chasis



Bastidor

Estructura tipo cajón fabricada en acero de alta resistencia y baja aleación. Orejetas de amarre delanteras y traseras.



Estabilizadores

Cuatro estabilizadores hidráulicos telescópicos de doble viga con gatos invertidos y válvulas de retención integradas. Tres ajustes de posición: 0%, 50% y totalmente extendidos. Base de los estabilizadores de montaje rápido, fabricadas completamente en acero de 775 mm. de diámetro.

Carga máxima sobre cada placa de apoyo: 56 700 kg.
Controles e indicador del nivel de la grúa situados en la cabina.



Motor

Cummins QSB 6,7L diesel seis cilindros, 275 CV, 205 kW a 2 500 rpm.
Par motor máximo : 987 Nm a 1 500 rpm.



Transmisión

Powershift secuencial con 6 velocidades adelante y 6 atrás.



Tracción/Dirección

4 x 4.

Dirección totalmente asistida independiente entre ejes :
Delantera : Totalmente hidráulica, controlada por volante.
Trasera : Totalmente hidráulica, controlada por interruptor.
Infinitamente variable en los 4 modos de dirección principales : sólo delantera, sólo trasera, control de giro (tipo cangrejo) y coordinada.
Indicador de dirección trasera. Radio de giro: 7,5 m.



Ejes

Delantero : Tracción/dirección con reducción planetaria y diferencial, montaje rígido en la estructura.

Trasero : Tracción/dirección con reducción planetaria y diferencial, montaje pivotante en la estructura.



Neumáticos

29,5 x 25 – 34 lonas.



Frenos

Circuito de frenos totalmente hidráulico operando sobre todas las ruedas. Freno de estacionamiento montado sobre el eje delantero que se acciona mediante resorte y se libera hidráulicamente.



Luces

Iluminación completa que incluye intermitentes, indicadores superiores, traseros, de freno y de peligro.



Velocidad máxima

35 km/h.



Inclinación (teórica)

75 % basado en peso bruto del vehículo de 49.060 kg, neumáticos de 29,5 x 25, pluma de 39,0 m más plumín de 17,1, contrapeso de 8165 kg, gancho de 75 t y bola de demolición de 9 t.



Sistema eléctrico

Dos baterías de 12V sin mantenimiento. Arranque e iluminación de 12V.
Desconexión de la batería. Sistema de diagnóstico CanBus.

* Equipamiento opcional

- Marca de conformidad CE.
- Paquete de iluminación auxiliar (incluye luz intermitente ámbar montada sobre la cabina, luz de trabajo montada en el mecanismo de elevación y luces de resalte dobles montadas en la pluma base.)
- Barra de iluminación del LMI (en la cabina).
- Bloqueo de oscilación estilo NYC de 360 grados.
- Gancho trasero con pasador de cadena.
- Bloqueos del diferencial de eje cruzado controlados desde la cabina (delanteros y traseros).
- Registrador de datos PAT.
- Alfombrilla de goma para hueco de almacenamiento.

*Indica equipo opcional.

Caratteristiche tecniche

Sovrastruttura



Braccio

Braccio con sfilamento idraulico sequenziale - sincronizzato a quattro sezioni da 12,6 a 39,0 m. Altezza massima in punta: 41,9 m.



*Jib telescopico ripiegabile

Jib telescopico tralicciato inclinabile da 10 - 17,1 m. Inclinabile a 0°, 20° e 40°. Alloggiabile lungo la sezione del braccio. Altezza massima in punta: 58,6 m.



*Sezioni intermedie

2 x 6,1 m sezioni intermedie tralicciate. Installabili tra la punta del braccio ed il falcone, non alloggiabili lungo il braccio. Altezza massima in punta: 70,6 m.



Sollevamento braccio

Un cilindro idraulico a doppia azione con valvola di blocco integrale fornisce il sollevamento braccio con angolo da -3° a +78°.



Limitatore di carico e finecorsa

Momento di carico standard con display grafico, sistema anti-doppio bloccaggio con allarme e bloccaggio dei movimenti. Visualizzazione grafica dell'angolo del braccio, lunghezza, raggio, altezza in punta, indicazione del carico e del carico ammissibile massimo. Il sistema standard di definizione dell'area di lavoro permette all'operatore di preselezionare e definire le aree di lavoro sicure. Se l'autogru si avvicina ai limiti preimpostati, degli allarmi acustici e visivi aiutano l'operatore ad evitare gli ostacoli sul posto di lavoro.



Cabina

Ottima visibilità, costruita completamente in acciaio, insonorizzata. La cabina si inclina fino a +20°. Il sedile ergonomico è dotato di comandi elettrici a doppio asse integrati nei braccioli. Il cruscotto incorpora la strumentazione per tutte le funzioni del motore. Altre caratteristiche standard comprendono: volante inclinabile, riscaldamento ad acqua, ventola per la circolazione dell'aria nella cabina, finestrini scorrevoli, lava/tergicristallo elettrico, estintore e cintura di sicurezza. AC.



Rotazione

Doppia velocità di rotazione con riduttore planetario e freno idraulico a disco multiplo azionato a pedale. Freno di stazionamento a molla rilasciato idraulicamente. Bloccaggio con perno meccanico in posizione frontale con azionamento dalla cabina. Velocità massima: 2,0 giri/minuto.



Contrappeso

8 165 kg. Installato e rimosso idraulicamente.



Impianto idraulico

2 pompe principali (una a pistoni assiali e una a ingranaggi) con capacità totale di 503 l/min. Pressione operativa massima: 277,7 bar. Valvola di controllo principale a tre sezioni a pressione compensata. Filtro sulla linea di ritorno non bypassabile e indicatore di manutenzione. Cartuccia sostituibile con microfiltraggio di 5/12/16. Capacità del serbatoio idraulico: 995 l. Prese per la misura della pressione del sistema. Scambiatori di calore di serie per l'olio idraulico e l'olio della trasmissione.



Specifiche dell'argano principale e ausiliario

Riduttore planetario e freno negativo multidischi ad azionamento automatico. Indicatore elettronico di rotazione del tamburo sul joystick e guide per cavo tamburo argano.

Tiro massimo con singola fune:

- Primo strato: 9 185 kg.
- Terzo strato: 7 716 kg.
- Quinto strato: 6 650 kg.

Tiro massimo permesso sulla fune: 7 620 kg con fune di classe 6X37.

7 620 kg con fune di classe 35X7, anti-giro.

Velocità massima con singola fune : 156 m/min.

Costituzione della fune: 6 x 36 EIPS IWRC, flessibilità speciale 35x7 Flex-X, anti-giro.

Diametro fune : 19 mm.

Lunghezza della fune : sull'argano principale e ausiliario : 183 m

Massima capacità di avvolgimento della fune sul tamburo : 256 m.

Carro



Telaio

Quattro stabilizzatori in sezioni scatolate realizzate in acciaio al alta resistenza. Occhioni di traino e di fissaggio anteriori e posteriori.



Stabilizzatori

Quattro stabilizzatori ad azionamento idraulico e cilindri a stelo rovesciato, valvole di blocco integrali. Impostazione a tre posizioni, 0%, 50% e completamente estesi. Costruzione completamente in acciaio, piatti stabilizzatori quadrati del tipo a rilascio rapido, con lato 775 mm. Carico massimo piatti stabilizzatori: 56 700 kg. Comandi e indicatore di livello della gru situati all'interno della cabina.



Motore

Diesel Cummins QSB da 6,7 l, 6 cilindri, 275 CV, 205 kW (lordi) a 2500 giri al minuto. Coppia max : 987 Nm a 1500 giri al minuto.



Cambio

Cambio a 6 rapporti (3 marce x 2 velocità) in avanti e 3 retromarce.



Trazione/Sterzo

4 x 4.

Idroguida completamente indipendente:

Anteriore : completamente idraulico azionato tramite il volante.

Posteriore : completamente idraulico azionato con interruttore.

Fornisce 4 modalità di sterzata: solo anteriore, solo posteriore, a granchio e combinata. Indicatore di allineamento delle ruote posteriori.

Raggio di sterzo : 7,5 m.



Assali

Anteriore : Montato rigido sul telaio, trazione con differenziale e mozzini di riduzione planetaria.

Posteriore : Su culla oscillante, trazione con differenziale e mozzini di riduzione planetaria montati.



Pneumatici

29,5 x 25 - 24 strati trasversali.



Freni

Doppio circuito completamente idraulico agente su tutte le ruote.

Freno di stazionamento negativo ad azionamento idraulico agente sull'asse anteriore.



Luci

Illuminazione completa compresi indicatori di direzione, luci anteriori, posteriori, freno e luci di segnalazione pericolo.



Velocità massima

35 km/h.



Pendenza (teorica)

75% basato su peso lordo di 49.060 kg, pneumatici 29,5 x 25, braccio da 39,0 m più falcone da 17,1 m, contrappeso da 8.165 kg, gancio di blocco da 75 t e sfera da 9 t.



Impianto elettrico

2 batterie da 12 V. Avviamento e illuminazione a 12 V.

Interruttore di disconnessione, sistema di controllo CAN-Bus.

* Equipaggiamenti opzionali

- Marcatura di conformità CE.
- Pacchetto di illuminazione ausiliario (comprende luci lampeggianti ambra montate in cabina, luce di lavoro montata sull'argano, e proiettori montati su braccio a base doppia.)
- Barra luminosa LMI (in cabina).
- Bloccaggio meccanico della rotazione a 360° (tipo NYC).
- Gancio del rimorchio posteriore.
- Bloccaggio differenziali trasversali controllati dalla cabina (anteriore e posteriore)
- Registratore di dati PAT.
- Tappetino di gomma vano di stivaggio.

*Indica attrezzature opzionali

Superestrutura



Lança

12,6 m – 39,0 m. Lança de quatro secções, de telescopagem hidráulica, sincronizada. Altura máxima da ponta da lança : 41,9 m.



*Extensão swingaway fixa

Extensão swingaway de 10 a 17,1 m da estrutura oscilante bipartida. Angulações de 0°, 20° e 40°. Acondiciona-se ao longo da secção da lança base. Altura máx. da cabeça da extensão: 58,6 m.



*Extensão swingaway telescópica

2 extensões de 6,1 m da estrutura. Instalam-se entre a ponta da lança e a extensão bipartida, não acondicionáveis. Altura máx. da cabeça da extensão: 70,6 m.



Elevação da lança

Um cilindro hidráulico de acção dupla com válvula anti-retorno integral assegura a elevação de -3° a +78°.



Sistema de momento de carga e fim de curso do cadernal

“Indicador gráfico” standard do momento de carga e do sistema de fim de curso do cadernal com sistema audiovisual de sinalização e dispositivo de bloqueio automático das alavancas de comando. Estes sistemas fornecem informações, apresentadas em visor electrónico, do ângulo da lança, do comprimento, do raio, da altura da ponta da lança, do momento de carga relativo, da carga máxima admitida, da indicação de carga e aviso sobre o fim de curso do cadernal. O Sistema de Definição da Área de Trabalho standard permite ao operador seleccionar previamente e definir áreas de trabalho. Se a grua se estiver a aproximar dos limites previamente definidos, avisos audiovisuais ajudam o operador a evitar obstruções no local da obra.



Cabine

Cabine panorâmica, integralmente feita de aço, com isolamento sonoro e vidro de segurança colorido a toda a volta. Cabine inclinável até +20 graus. O assento Deluxe integra controladores de eixo duplo, eléctricos, instalados no apoio para os braços. O painel de controlo está equipado com manómetros para todas as funções do motor. Entre as demais funcionalidades standard incluem-se: Volante inclinável, aquecedor da cabine de água quente, ventoinha de circulação do ar na cabine, janelas lateral e traseira deslizantes, vidro de tejadilho deslizante com limpa-vidros eléctrico e pala para o sol, lava e limpa pára-brisas eléctricos, extintor de incêndios e cinto de segurança. AC.



Rotação

Accionamento da rotação de planetários, de 2 velocidades, com travão em banho de óleo, tipo multidisco com aplicação com o pé. Travão de imobilização de mola e de libertação hidráulica. Dispositivo de bloqueio mecânico, de uma posição, accionado a partir da cabine. Velocidade máxima : 2,0 rpm.



Contrapeso

8 165 kg. Instalado e desmontado por meios hidráulicos.



Sistema hidráulico

Dois bombas principais (1 de pistão e 1 de engrenagens) com uma capacidade combinada de 503 l/min). Pressão de serviço máxima: 277,7 bar. Três conjuntos de válvulas de pressão compensada. Filtro no circuito de retorno com protecção por derivação de débito total e indicador de manutenção. Cartucho substituível com classe de filtragem micrométrica de 5/12/16. Depósito de 995 l. Tomadas para teste da pressão do sistema.



Guincho

Redutor de planetários com travão em banho de óleo multidiscos de mola, automático. Indicadores electrónicos da rotação do tambor de elevação e acamador de cabo no tambor de elevação.

Esforço máximo no cabo singelo:

- Primera camada: 9 185 kg.
- Terceira camada: 7 716 kg.
- Quinta camada: 6 650 kg.

Esforço máximo admitido no cabo singelo: 7 620 kg com cabo da classe 6x37.
7 620 kg com cabo da classe 35x7 resistente à rotação.

Velocidade máxima do cabo singelo : 156 m/min.

Tipo de Cabo: 6x37 EIPS IWRC, flexível especial.
35x7 Flex-X resistente à rotação.

Diâmetro do Cabo: 19 mm.

Comprimento do cabo: Guincho principal e auxiliar : 183 m

Capacidade Máxima do Cabo : 256 m.

Chassis



Chassis do transportador

Chassis de caixa em aço de alta resistência. Olhais de fixação e de reboque dianteiros e traseiros.



Estabilizadores

Quatro vigas de estabilização hidráulicas e telescópicas, de caixa dupla, de secção simples, com macacos invertidos e válvulas anti-retorno integrais. Três posições : 0%, 50% e totalmente estendidas. Sapatas de apoio, integralmente feitas de aço, de libertação rápida, diâmetro 775 mm. Carga máxima nas sapatas : 56 700 kg. Comandos de estabilização e indicador de nível instalados no interior da cabine.



Motor

Motor a gasóleo Cummins QSB 6.7L, de seis cilindros, de 275 CV, 205 kW (brutos) a 2 500 rpm. Binário máximo: 987 Nm a 1 500 rpm.



Transmissão

Transmissão Powershift sequencial com 6 velocidades de marcha avante e 6 velocidades de marcha-atrás.



Tracção/direcção

4 x 4.

Direcção assistida de comando independente:

À frente : totalmente hidráulica, comandada pelo volante.

Atrás : totalmente hidráulica, comandada por interruptor.

Disponibiliza um número infinito de variações dos 4 principais modos de direcção: só dianteira, só traseira, direcção tipo caranguejo e direcção coordenada. Indicador de direcção traseira. Raio de viragem : 7,5 m.



Eixos

Dianteiros : Eixo de tracção/direcção com cubos do redutor de planetários e diferencial rigidamente montados no chassis.

Traseiros : Eixo de tracção/direcção com cubos do redutor de planetários e diferencial montados no chassis de forma articulada (pivôs).



Pneus

Pneus 29,5 x 25 - 34 telas.



Travões

Travões de circuito dividido, totalmente hidráulicos, que actuam sobre todas as rodas. Travão de estacionamento de mola e de libertação hidráulica, montada no eixo dianteiro.



Iluminação

Conjunto completo, incluindo luzes de sinalização de mudança de direcção, faróis dianteiros, faróis traseiros, luzes de travagem e luzes de sinalização de perigo.



Velocidade máxima

35 km/h.



Gradabilidade (teórica)

75 % baseado em PB 49 060 kg, pneus 29,5 x 25, lança 39,0 m, mais swingaway 17,1, contrapeso 8165 kg, bloco de gancho 75 t e bola com gancho 9 t.



Sistema eléctrico

Dois baterias de 12 V que dispensam manutenção. Arranque e luzes de 12 V. Interruptor de desconexão da bateria. Sistema de diagnóstico CanBus.

* Equipamento opcional

- Conformidade com a Marca CE
- Conjunto de iluminação auxiliar (inclui luz intermitente âmbar montada na cabine, luz de trabalho montada no mecanismo de elevação e dois faróis de trabalho montados na base da lança).
- Barra de iluminação do LMI (na cabine).
- Bloqueio de oscilação mecânico estilo NYC de 360°.
- Gancho traseiro para corrente.
- Bloqueios do diferencial do eixo cruzado controlados na cabine (dianteiros e traseiros).
- Registador de dados PAT.
- Tapete de borracha para a caleira de armazenamento.

*Assinala o equipamento opcional

Технические характеристики

Крановая установка



Стрела

Четырехсекционная телескопическая стрела длиной 12,6 – 39,0 м с синхронизированным выдвижением. Максимальная высота оголовка стрелы: 41,9 м.



*Фиксированный удлинитель стрелы

Складной решетчатый удлинитель стрелы 10 - 17,1 м. Возможность установки под углом на 0°, 20° или 40°. Складывается вдоль секции основной стрелы. Максимальная высота оголовка удлинителя: 58,6 м.



*Промежуточные вставки удлинителя стрелы

2 решетчатых вставки длиной 6,1 м. Устанавливаются между оголовком стрелы и складным удлинителем. Не складываются. Максимальная высота оголовка удлинителя стрелы: 70,6 м.



Угол наклона стрелы

Один гидравлический цилиндр двойного действия со встроенным обратным клапаном обеспечивает подъем от -3° до +78°.



Ограничитель грузовой нагрузки и ограничитель высоты подъема крюка

Стандартный ограничитель грузовой нагрузки с графическим дисплеем и система блокировки при переподъеме с звуковой и визуальной сигнализацией и блокировкой органов управления. Эти системы выводят на электронный дисплей угол наклона стрелы, длину, радиус, высоту оголовка стрелы, относительный грузовой момент, максимально допустимую нагрузку, текущую нагрузку и предупреждение о возможности перегруза. Стандартная система ограничения рабочей зоны позволяет оператору заранее выбрать и определить безопасные рабочие зоны. При приближении крана к установленным границам срабатывает звуковая и визуальная сигнализация предупреждения оператора.



Кабина

Полностью стальная кабина с круговым обзором, звукоизоляцией и тонированными небьющимися стеклами по всему периметру. Наклон кабины до +20 градусов. Высококачественное сиденье оборудовано встроенными в подлокотники органами управления с одноосевым перемещением. Контрольные приборы для всех рабочих функций выведены на приборную панель. Остальные опции, включенные в стандартную поставку: обогреватель на горячей воде, вентилятор, раздвижные боковые и задние стекла, раздвижная застекленная крыша с электрическим стеклоочистителем и солнцезащитным экраном, электроомыватель и очиститель лобового стекла, огнетушитель и ремень безопасности, воздушный кондиционер.



Поворот

Двухскоростной, привод механизма поворота через планетарный редуктор с жидкоохлаждаемым многоскоростным тормозом. Пружинный, гидравлически отпускаемый тормоз механизма поворота. Механическая блокировка крановой установки в одном положении, выполняемая из кабины. Максимальная скорость: 2 об./мин.



Противовес

8165 кг. Гидравлическая система монтажа.



Гидравлическая система

Два главных насоса ([1] поршневой и [1] шестеренчатый) с общей мощностью мощностью 503 LPM. Максимальное рабочее давление: 277,7 бар. Трехсекционная группа клапанов с компенсацией давления. Фильтр возвратной магистрали с полнопоточной обходной защитой и индикатором обслуживания. Сменный картридж, минимальный размер частиц, удаляемых фильтром - 5/12/16. Бак на 995 л. Устанавливаемый на опоре масляный радиатор с термостатом и вентиляторным охлаждением с приводом от гидравлического мотора. Контрольные отверстия для проверки давления системы.



Лебедка подъема

Планетарный редуктор с автоматическим пружинным многоскоростным жидкоохлаждаемым тормозом. Электронные индикаторы вращения подъемного барабана и кабельные держатели.

Максимальное натяжение каната при однократной запуске:

• 1 слой: 9 185 кг. • 3 слой: 7 716 кг. • 5 слой: 6 650 кг.

Максимально допустимое натяжение каната:

7620 кг с канатом класса 6X37 - 7620 кг с устойчивым к скручиванию канатом 35X7.

Максимальная скорость каната при однострунной оснастке: 156 м/мин.

Конструкция каната: 6X36 с сердечником из высокопрочной стали для подъемных канатов особой гибкости, высокого качества.

35x7 Flex-X, устойчивый к скручиванию

Диаметр каната: 19 мм. Длина каната: Лебедка основного подъема: 183 м -

Лебедка вспомогательного подъема: 183 м.

Максимальная длина укладки каната: 256 м.

10

Тягач



Шасси

Коробчатая рама выполнена из высокопрочной низколегированной стали. Передние/задние буксировочные и крепёжные проушины.



Выносные опоры

Четыре гидравлические телескопические одноступенчатые двухмуфтовые балочные выносные опоры с перевернутыми цилиндрами и встроенными блокирующими клапанами. 3 позиции выдвижения: 0%, 50% и на полную длину. Стальные, легко доступные опоры диаметром 775 мм. Максимальная нагрузка на подушку выносной опоры: 56 700 кг. Органы управления и указатель уровня крана расположены в кабине.



Двигатель

Дизельный, 6-цилиндровый двигатель Cummins QSB объемом 6,7 л, мощностью 275 л/с, 205 кВт (полная мощность) на 2 500 об./мин. Максимальный крутящий момент: 987 Нм при 1 500 об/мин.



Трансмиссия

Последовательная коробка переключения передач с 6 передними и 6 задними скоростями.



Ведущие/управляемые колеса

4 x 4.

Полностью независимое рулевое управление с усилителем:

Передние: С полным гидравлическим усилением. Управление от рулевого колеса.

Задние: С полным гидравлическим усилением. Ручное управление с помощью переключателей.

Возможны многочисленные варианты 4 основных режимов рулевого управления: только передние, только задние, крабовый ход и согласованный режим. Индикатор заднего движения. Радиус разворота: 7,5 м.



Оси

Передняя: Ведущая с управляемыми колесами, с дифференциальными и планетарными колесными редукторами, жестко смонтированными на раму. Задняя: Ведущая с управляемыми колесами, с дифференциальными и планетарными колесными редукторами, шарнирно закрепленными на раму.



Шины

29,5 x 25 - 34 с диагональным кордом.



Тормоза

Полностью гидравлические, раздельные на все колеса. Пружинный, гидравлически отпускаемый парковочный тормоз, закрепленный на передней оси.



Фары

Полное освещение, включая индикаторы поворота, передние, задние, тормозные фары и лампы аварийной сигнализации.



Максимальная скорость

35 км/ч.



Преодолеваемый уклон (теор.)

75 % на базе 49060 кг (полная масса), шины 29,5 x 25, стрела 39,0 м, плюс складной удлинитель 17,1, противовес 8165 кг, крюковый блок 75 т и шаровая баба 9 т.



Электросистема

Две, не требующие обслуживания, батареи на 12 В. Напряжение запуска и освещения - 12 В. Отключение батарей. Система диагностики CanBus.

* Дополнительное оборудование (по выбору)

- Соответствие нормам Евросоюза.
- Дополнительный пакет освещения (фонарь желтого мигающего света в кабине, фонарь на лебедке и двойные прожекторы на основной стреле).
- Световая панель ограничителя грузовой нагрузки (в кабине).
- Механический фиксатор поворота типа NYC на 360°.
- Задний поворотный буксирный крюк.
- Механизм блокировки межколесного дифференциала, (передний и задний).
- Регистратор данных РАТ.
- Резиновый коврик на пол.

*Дополнительное оборудование



Axle • Achse Essieu • Eje Asse • Eixos • Оси	1	2	Total weight • Gesamtgewicht Poids total • Peso total Peso totale • Peso total Суммарный вес
	t	t	
Basic machine • Grundausführung • Configuration standard Maquina básica • Macchina base • Máquina base • Базовый кран	24,4	24,6	49,0
Remove counterweight and aux. Hoist Gegengewicht und Hilfshubwerk abgebaut Retirer le contrepoids et le treuil auxiliaire Retirando contrapeso y cabrestante auxiliar Rimuovere il contrappeso e l'argano ausiliario Remover o contrapeso e guincho auxiliar Без противовеса и всп. лебедки	28,8	11,1	39,9
Remove counterweight, aux. Hoist and bifold swingaway Gegengewicht, Hilfshubwerk und Doppelklappspitze abgebaut Retirer le contrepoids, le treuil auxiliaire et l'extension treillis double Retirando contrapeso, cabrestante auxiliar y plumín plegable Rimuovere il contrappeso, l'argano ausiliario e il falcone ripiegabile Remover o contrapeso, o guincho auxiliar e a estrutura oscilante bipartida Без противовеса, всп. лебедки и складного удлинителя стрелы	26,6	12,0	38,7



Lifting Capacity Traglast Force de levage Capacidad de elevación Capacità di sollevamento Capacidade de elevação Грузоподъемность	Sheaves Rollen Pouliés Poleas Carrucolo Roldanas Шкивы	Parts of line Stränge Brins Ramales de cable Numero di funi Partes de cabo Кратность запасовки	Total weight Gesamtgewicht Poids total Peso total Peso totale Peso total Суммарный вес
75 t	5	9	725 kg
9 t	H/B (swivel)	1	257 kg



	Ininitely variable Stufenlos Progressivement variable Infinitamente variable Infinitamente variabile Infinitamente variável Плавно-изменяемый	Rope Seil Câble Cable Fune Cabo Канат	Permissible line pull max. Max. Seilzug Effort maxi au brin Tracciones del cable admisibles Trazioni ammissibili della linea Esforços admitidos nos cables Максимально допустимое натяжение каната	Nominal cable length Seillänge (Nennwert) Longueur nominale des cables Longitud nominal del cable Lunghezza nominale cavo Comprimento nominal de cabo Номинальная длина каната
	0 - 156 m/min single line / bei einfachem Strang brin simple / ramal simple tiro a fune singola / cabo singolo Однократная запасовка	19 mm (6x37 class)	7 620 kg	183 m
	0 - 156 m/min single line / bei einfachem Strang brin simple / ramal simple tiro a fune singola / cabo singolo Однократная запасовка	19 mm (Flex - X 35)	7 620 kg	183 m
	0 - 2,0 min ⁻¹			
	-3° to +78° approx. 55 s ca. 55 s • env. 55 s aproximadamente 55 s circa 55 s • cerca de 55 s примерно 55 с			
	12,9 to 39,0 m approx. 115 s ca. 115 s • env. 115 s aproximadamente 115 s circa 115 s • cerca de 115 s примерно 115 с			

Dimensions • Abmessungen • Encombrement • Dimensiones
 • Dimensioni • Dimensões • Размеры

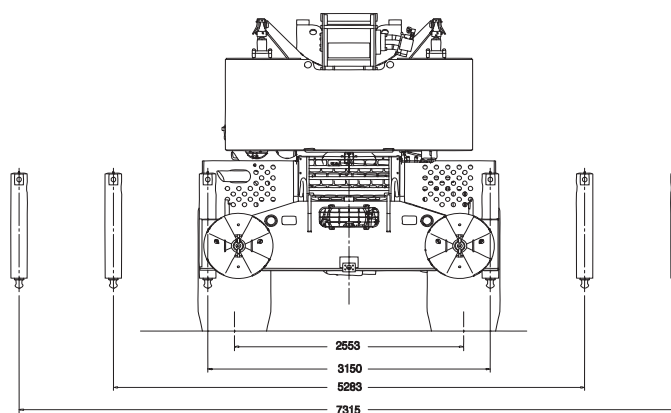
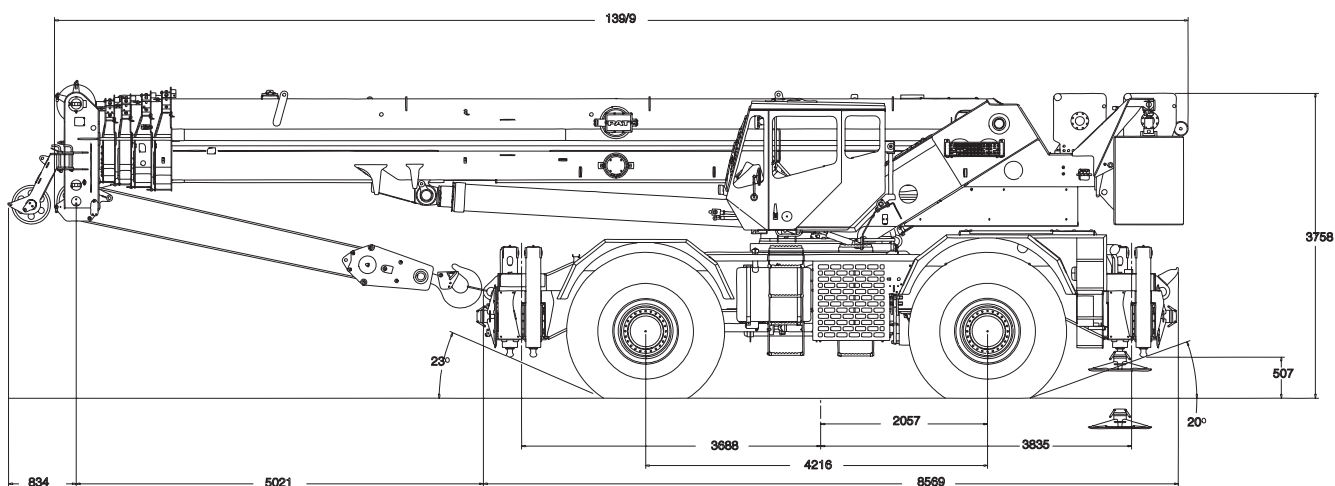
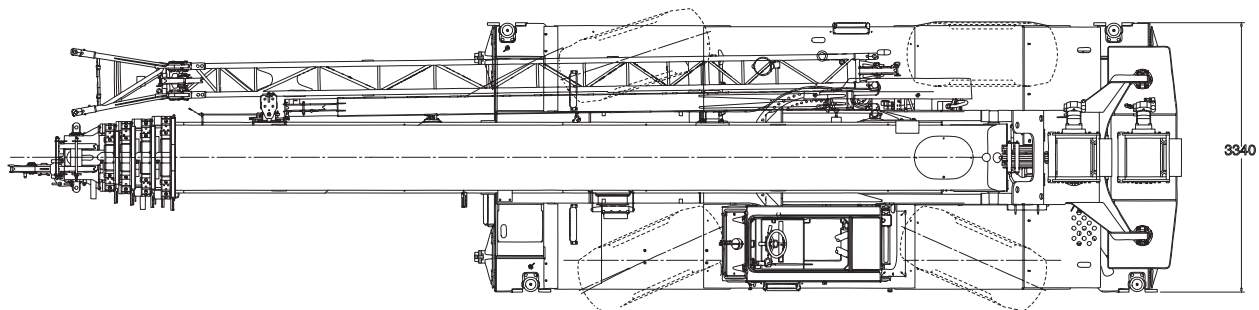

Note: Reference dimensions in mm • Hinweis: Bezugsmaße in mm • Remarque : cotes de référence en mm •
 Nota: Dimensiones de referencia en mm • Nota: Dimensioni di riferimento in mm • Nota: Dimensões de referência em mm •
 Примечание: Справочные размеры (в мм)

Load charts • Traglasten • Capacités de levage • Capacidades de carga • Diagramas de carga • Таблицы грузоподъемности

Notes • Hinweise • Notes • Notas • Note • Notas • Примечания

Lifting capacities according to DIN/ISO • 85%

Warning: THIS CHART IS ONLY A GUIDE. The Notes below are for illustration only and should not be relied upon to operate the crane. The individual crane's load chart, operating instructions and other instruction plates must be read and understood prior to operating the crane.

DIN/ISO: The mechanical strength complies with DIN 15018, part 3. Tipping conditions are governed by DIN 15019, part 2 and ISO 4305 standards. They also take into account the requirements of prEN 13000: 2003 and therefore comply with the requirements of the EU machinery directive.

85%: Capacities are in accordance with SAE J1063 and do not exceed 85% of the tipping load (SAE J1289 for outriggers 50% and 0% extended) as determined by SAE J765.

1. Capacities given do not include the weight of hookblocks, slings, auxiliary lifting equipment and load handling devices. Their weights MUST be added to the load to be lifted. When more than minimum required reeving is used, the additional rope weight shall be considered part of the load.
2. All capacities are for crane on firm, level surface. It may be necessary to have structural supports under the outrigger floats or tyres to spread the load to a larger bearing surface.
3. When either boom length or radius or both are between values listed, the smallest load shown at either the next larger radius or boom length shall be used.
4. For outrigger operation, ALL outriggers shall be fully extended with tyres raised free of ground before raising the boom or lifting loads.
5. Tyres shall be inflated to the recommended pressure before lifting on rubber.

Traglasten entsprechen DIN/ISO • 85%

WARNUNG: DIESE TABELLE IST LEDIGLICHE EINE RICHTLINIE. Die Hinweise dienen als Erklärung und sind für die Kranbedienung nicht maßgebend. Vor Inbetriebnahme des Kranes sind Traglasttabellen, Bedienungsanleitung und andere Vorschriften eingehend zu studieren.

DIN/ISO: Der Festigkeitsberechnung liegen die DIN 15018 Teil 3 zugrunde. Die Traglasten im Standsicherheitsbereich entsprechen DIN 15019 Teil 2 und ISO 4305. Sie berücksichtigen außerdem die Forderungen von prEN 13000: 2003 und entsprechen damit den Anforderungen der Maschinenrichtlinie.

85%: Tragkraftwerte entsprechen SAE J1063 und überschreiten nicht 85 % der Kippplast (SAE J1289 bei halb- bzw. ganz ausgefahrener Abstützung) gemäß Richtlinien SAE J 765.

1. Das Gewicht der Hakenflaschen und aller Anschlagmittel muß zu der Last hinzugerechnet werden. Beim Einscheren mit erhöhten Werten ist das zusätzliche Seilgewicht als Teil der Last zu betrachten.
2. Alle Werte gelten für den Kran auf festem, ebenem Untergrund. Eventuell müssen die Stützsteller oder Reifen unterlegt werden, um die Last über eine größere Abstützfläche zu verteilen.
3. Wenn Auslegerlänge oder Radius oder beide Werte zwischen den aufgeführten Werten liegen, ist die geringere der Traglasten zu wählen, die für den die nächstgrößere Ausladung oder die nächste bzw. anschließende Auslegerlänge genannt sind.
4. In abgestütztem Zustand müssen ALLE Stützen komplette ausgefahren sein. Die Reifen dürfen den Boden nicht berühren. Erst danach dürfen Lasten oder der Ausleger angehoben werden.
5. Reifen frei auf Rädern gearbeitet wird, müssen, die Reifen mit dem vorschrittsmäßigen Druck aufgefüllt werden.

Capacités de levage selon DIN/ISO • 85%

ATTENTION: CE TABLEAU N'EST QU'UN GUIDE. Les notes ci-dessous sont données à titre d'exemple et ne devront pas être utilisées pour faire fonctionner la grue. Toute la documentation concernant chaque type de grue: tableau des charges, instructions de fonctionnement et toutes autres plaques d'instructions devront être lues et comprises avant de manoeuvrer la grue.

DIN/ISO: Les limites du basculement sont conformes à la norme DIN 15019 section 2 et ISO 4305. Elles tiennent également compte des paramètres établis pour le projet de norme Européenne prEN 13000: 2003 et de ce fait satisfont les exigences de la Directive Européenne Machines.

85%: Les capacités de levage sont conformes à la norme SAE J1063 et ne dépassent pas 85% de la charge de basculement (SAE J1289 pour les poutres de calage déployées à 50% et 0%) tel que cela est prescrit par la norme SAE J765.

1. Les charges mentionnées dans les tableaux ne comprennent pas le poids des moufles, des élingues et autres accessoires de levage qui doit être additionné à celui de la charge levée. Lorsque le mouflage est supérieur au minimum requis le poids de l'excédent de câble doit être additionné à celui de la charge.
2. Les capacités sont données sur sol ferme et de niveau. Il peut être nécessaire d'utiliser des bastingins ou des accessoires similaires afin de répartir la charge transmise au sol par les roues ou les patins de calage.
3. Lorsque la longueur de flèche ou la portée ne correspond pas aux valeurs mentionnées dans les tableaux, il convient de se référer à la valeur inférieure mentionnée pour la portée ou la longueur de flèche immédiatement supérieure.
4. Pour utilisation machine calée, les poutres de calage doivent être totalement télescopées et les roues décollées du sol avant de relever la flèche ou de lever des charges.
5. Les pneumatiques devront être gonflés aux pressions préconisées avant tout levage en libre.

Capacidades de elevación de acuerdo con DIN/ISO • 85%

AVISO: ESTA TABLA ES SOLO UNA ORIENTACION. Las notas que aparecen al final de la misma solo sirven de ilustración y no deben ser tomadas como instrucciones para operar la grúa. La tabla de cargas, las instrucciones de operación y otras placas ilustrativas de cada grúa deben ser leídas y correctamente interpretadas antes de operar la grúa.

DIN/ISO: Los análisis de resistencia están basados en las normas DIN 15018. Apartados 3. Las condiciones de vuelco están reguladas por las normas DIN 15019 apartado 2 y ISO 4305. Tienen también cuenta de las exigencias establecidas por prEN 13000: 2003 y así cumplen con los requerimientos de las Directivas de Maquinaria UE.

85%: Capacidades de acuerdo con las Normas SAE J1063 y no exceden del 85% del momento de vuelco (Normas SAE J1289 para las cargas sobre estabilizadores extendidos al 50% o sin extender 0%) como fijan las normas SAE J765.

1. Las cargas indicadas no incluyen el peso de los ganchos, eslingas, equipos auxiliares y aparejos de elevación. Sus pesos DEBEN ser añadidos al de la carga a elevar. Cuando se utilice un número de ramales de cable superior al necesario, el peso adicional del cable debe ser considerado como parte de la carga.
2. Todas las capacidades corresponden a la grúa situada sobre terreno firme nivelado y uniforme. La naturaleza del terreno puede hacer necesario colocar, bajo los apoyos de los estabilizadores o bajo los neumáticos, elementos estructurales que repartan la carga sobre una mayor superficie de apoyo.
3. Cuando se trabaje con longitudes de pluma o radios, intermedios entre los valores reflejados en las tablas, se considerará la carga inmediata inferior indicada en el radio o longitud de pluma inmediato superior.
4. Para trabajos sobre estabilizadores, TODOS los estabilizadores estarán totalmente extendidos y los neumáticos sin tocar el suelo antes de elevar pluma o izar cargas.
5. Los neumáticos deberán estar inflados a la presión recomendada antes de elevar cargas sobre neumáticos.

Capacità di sollevamento in accordo con DIN/ISO • 85%

ATTENZIONE: QUESTA TABELLA E' SOLO UNA GUIDA. Le note qui sotto riportate sono date a titolo d'esempio e non devono essere utilizzate per far funzionare la grua.

La tabella di carico, le istruzioni d'uso ed ogni altro foglio illustrativo devono essere letti e compresi prima di manovrare la grua.

DIN/ISO: il calcolo di resistenza è basato sulle norme DIN 15018, parte 3. Le condizioni di ribaltamento sono regolate dalle norme DIN 15019 parte 2 e ISO 4305. Esse tengono conto anche dei parametri stabiliti da prEN 13000: 2003 e quindi soddisfanno le richieste della Direttiva Macchine Europea.

85%: Le capacità di sollevamento sono conformi alla norma SAE J1063 e non superano l'85% del carico di ribaltamento (SAE J1289 per gli stabilizzatori estesi al 50% e 0%) come prescritto dalla norma SAE J765.

1. I carichi indicati nelle tavole non comprendono il peso dei ganci, dei tiranti, e di nessun altro accessorio di sollevamento che deve essere aggiunto a quello del carico sollevato. Quando il numero di funi è superiore al minimo richiesto il peso addizionale della fune deve essere aggiunto a quello del carico.
2. Tutte le capacità si intendono per la gru situata su un terreno compatto livellato e uniforme. Potrebbe rendersi necessario utilizzare dei supporti strutturali, sotto gli appoggi degli stabilizzatori o sotto i pneumatici, per ripartire il carico su una superficie di appoggio maggiore.
3. Quando la lunghezza del braccio o la portata non corrispondono ai valori riportati nelle tabelle, conviene considerare il valore inferiore riportato per il raggio di lavoro o la lunghezza del braccio immediatamente superiore.
4. Per lavoro su stabilizzatori, TUTTI gli stabilizzatori devono essere completamente estesi e i pneumatici staccati da terra prima di rialzare il braccio o di sollevare carichi.
5. I pneumatici devono essere gonfiati alla pressione raccomandata prima di sollevare carichi sopra i pneumatici.

Capacidade de elevação de acordo com as normas DIN/ISO • 85%

Atenção: ESTE QUADRO SERVE APENAS DE GUIA. As notas abaixo são dadas a mero título exemplificativo e não deverão ser utilizadas para operar a grua. Toda a documentação e instruções relativas a cada tipo de grua, nas quais se incluem o diagrama de carga da grua, as respectivas instruções de operação e outras placas com instruções, têm de ser lidas e compreendidas antes de a grua ser operada.

DIN/ISO: A resistência mecânica está em conformidade com o disposto na Parte 3 da norma DIN 15018. Os limites de basculamento são os impostos pela Parte 2 da norma DIN 15019 e pela norma ISO 4305. Além disso, também satisfazem os requisitos da norma europeia prEN 13000: 2003, estando assim em conformidade com as disposições da diretiva comunitária sobre máquinas.

85%: As capacidades estão em conformidade com as disposições da norma SAE J1063 e não ultrapassam 85% da carga de basculamento (norma SAE J1289 para estabilizadores estendidos 50% e 0%), conforme estipulado na norma SAE J765.

1. As capacidades indicadas não incluem o peso de cadernais, eslingas, equipamento auxiliar de elevação e dispositivos de manuseamento de cargas. Os seus pesos TÊM de ser adicionados ao peso da carga a ser elevada. Sempre que for utilizada uma quantidade de talhas superior à mínima exigida, o peso adicional dos cabos deverá ser considerado parte da carga, devendo ser adicionado ao seu peso.
2. Todas as capacidades são indicadas para uma grua sobre uma superfície firme e nivelada. Pode ser necessário colocar suportes estruturais por baixo dos pneus ou das sapatas dos estabilizadores, para espalhar a carga por uma superfície de suporte maior.
3. Sempre que o comprimento da lança, o seu raio, ou ambos estiverem compreendidos entre os valores indicados, deve ser utilizada a carga mais baixa indicada para o raio ou para o comprimento de lança imediatamente superior.
4. Operação com estabilizadores: Antes de a lança ser erguida ou de serem elevadas cargas, TODOS os estabilizadores têm de estar totalmente estendidos, com os pneus erguidos de modo a não estarem em contacto com o solo.
5. Antes de serem elevadas cargas sobre os pneus, eles devem ser enchidos às pressões recomendadas.

Грузоподъемность соответствует стандарту DIN/ISO • 85%

Внимание: ДАННАЯ СХЕМА ПРИВЕДЕНА ИСКЛЮЧИТЕЛЬНО В ОЗНАКОМИТЕЛЬНЫХ ЦЕЛЯХ. Нижеприведенные данные являются лишь пояснительными, на них не следует полагаться при работе с краном. Перед работой на кране следует прочесть и понять таблицы грузоподъемности, инструкции по эксплуатации, а также инструктирующие таблички.

DIN/ISO: Механическая прочность удовлетворяет стандарту DIN 15018, часть 3. Условия устойчивости определяются стандартами DIN 15019, часть 2 и ISO 4305. Также учитываются требования стандарта prEN 13000: 2003, а, следовательно, требования, приведенные в Европейских указания по охране труда в машиностроении.

85%: Нагрузка соответствует стандарту SAE J1063 и не превышает 85% от удерживающего момента (SAE J1289 для выносных опор, выдвигаемых на 50% и на 0%) в соответствии с SAE J765.

1. Указанная нагрузка не учитывает вес крюковых блоков, канатов, вспомогательного подъемного оборудования и погрузочно/разгрузочных устройств. Их вес СЛЕДУЕТ прибавлять к массе груза. При превышении минимально необходимой запаски канатаследует учитывать его дополнительный вес.
2. Все нагрузки указаны для крана, находящегося на прочной плоской поверхности. С целью распределения нагрузки, под выносные опоры или под колеса можно подложить поддерживающие конструкции для увеличения площади опоры.
3. Если длина стрелы, вылет (или и то и другое) находятся между указанными значениями в таблице, следует брать наименьшую нагрузку, указанную за следующим значением радиуса или длины стрелы.
4. Перед подъемом стрелы или грузов (при использовании выносных опор) следует выдвинуть ВСЕ выносные опоры на полную длину, чтобы колеса оказались над землей.
5. При подъеме с колес, шины должны быть накачаны до рекомендуемого давления.

Load charts • Traglasten • Capacités de levage • Capacidades Caracità • Diagramas de carga • Таблицы грузоподъемности

Working range • Arbeitsbereiche • Diagramme de levage • Gama de trabajo • Area di lavoro
Intervalo de funcionamento • Грузовысотные характеристики



12,6 – 39,0 m



100 %



360°



8,2 t

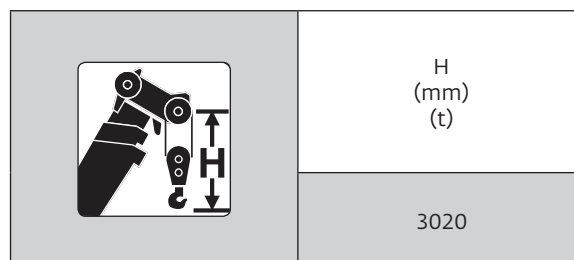
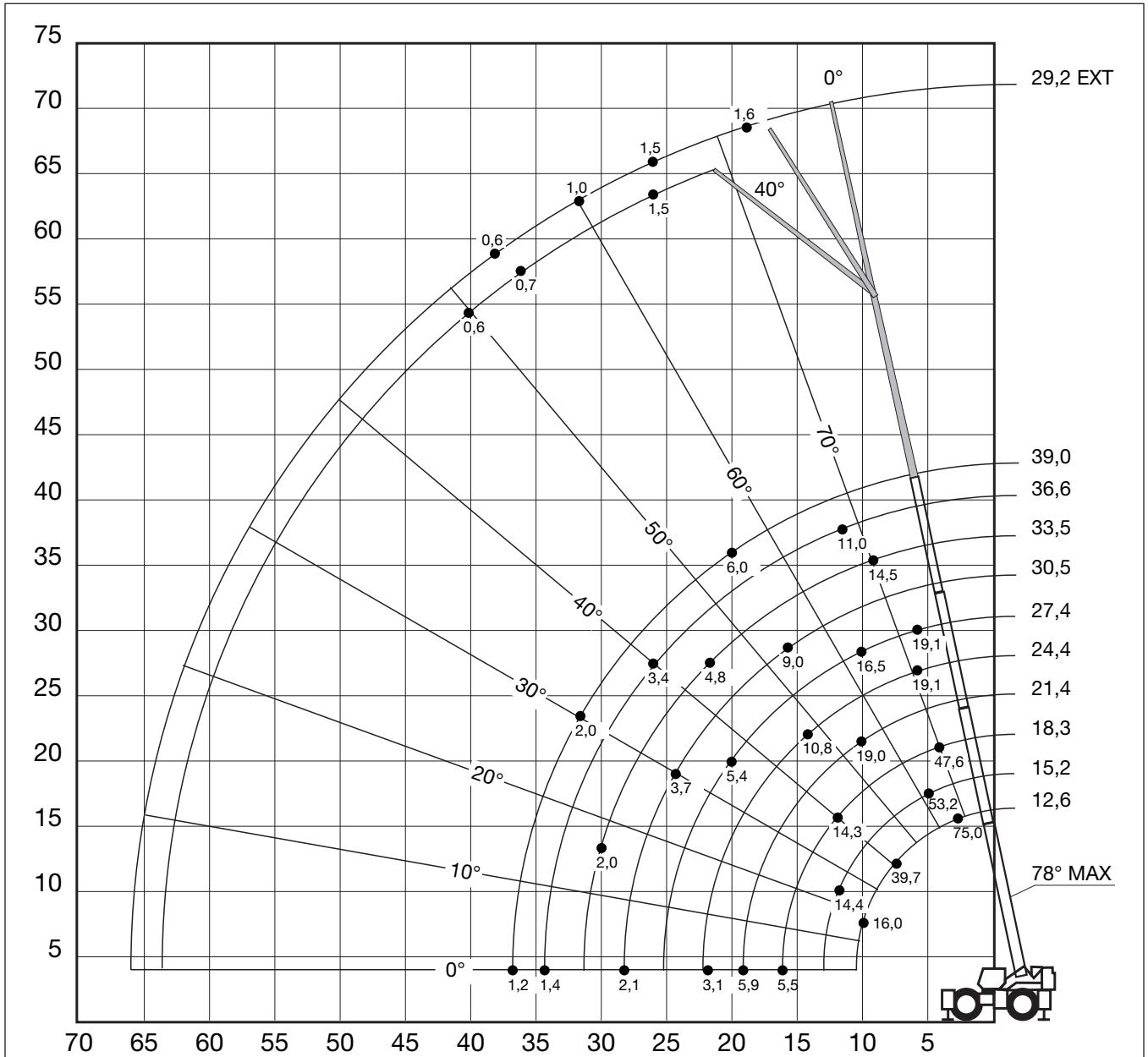

Load charts • Traglasten • Capacités de levage • Capacidades Caracità • Diagramas de carga • Таблицы грузоподъемности

Telescopic boom • Teleskopausleger • Flèche principale • Pluma telescópica • Braccio telescopico
Lança telescópica • Телескопическая стрела



12,6 – 39,0 m



100 %



360°



8,2 t



DIN/ISO

m	12,6	15,2	18,3	21,4	24,4	27,4	30,5	33,5	36,6	39,0
3,0	75,000	56,225	47,850	-	-	-	-	-	-	-
3,5	68,025	56,225	47,850	-	-	-	-	-	-	-
4,0	64,625	56,225	47,575	26,975	-	-	-	-	-	-
4,5	59,675	56,225	47,225	26,975	19,075	-	-	-	-	-
5,0	55,125	53,150	44,850	26,975	19,075	19,050	-	-	-	-
6,0	46,075	45,975	39,475	26,975	19,075	19,050	17,975	-	-	-
7,0	39,750	38,600	35,350	26,325	19,075	19,050	17,975	14,475	-	-
8,0	32,775	30,925	28,800	25,000	19,075	18,700	17,575	14,475	11,675	9,975
9,0	25,650	25,200	23,850	22,450	19,075	17,825	16,525	14,475	11,675	9,975
10,0	15,975	20,475	20,200	19,000	18,075	16,450	15,150	13,800	11,675	9,975
12,0	-	14,375	14,275	14,050	14,225	13,825	12,650	11,800	10,925	9,975
14,0	-	-	10,500	10,300	10,825	11,150	10,825	10,075	9,530	9,170
16,0	-	-	5,500	7,725	8,335	8,675	9,020	8,720	8,210	7,880
18,0	-	-	-	5,855	6,480	6,835	7,145	7,340	7,145	6,830
20,0	-	-	-	-	5,080	5,415	5,730	5,930	6,125	5,985
22,0	-	-	-	-	3,125	4,300	4,610	4,825	5,020	5,160
24,0	-	-	-	-	-	3,405	3,695	3,925	4,135	4,275
26,0	-	-	-	-	-	-	2,950	3,180	3,400	3,550
28,0	-	-	-	-	-	-	2,120	2,555	2,775	2,930
30,0	-	-	-	-	-	-	-	2,025	2,245	2,405
32,0	-	-	-	-	-	-	-	-	1,790	1,950
34,0	-	-	-	-	-	-	-	-	1,395	1,555
36,0	-	-	-	-	-	-	-	-	-	1,210

80005124



85 %

m	12,6	15,2	18,3	21,4	24,4	27,4	30,5	33,5	36,6	39,0
3,0	75,000	56,225	47,850	-	-	-	-	-	-	-
3,5	68,025	56,225	47,850	-	-	-	-	-	-	-
4,0	64,625	56,225	47,575	26,975	-	-	-	-	-	-
4,5	59,675	56,225	47,225	26,975	19,075	-	-	-	-	-
5,0	55,125	53,150	44,850	26,975	19,075	19,050	-	-	-	-
6,0	46,075	45,975	39,475	26,975	19,075	19,050	17,975	-	-	-
7,0	39,750	39,625	35,350	26,325	19,075	19,050	17,975	14,475	-	-
8,0	34,800	34,450	31,750	25,000	19,075	18,700	17,575	14,475	11,675	9,975
9,0	27,650	27,200	27,075	22,675	19,075	17,825	16,525	14,475	11,675	9,975
10,0	15,975	22,200	22,075	20,675	18,075	16,450	15,150	13,800	11,675	9,975
12,0	-	15,700	15,625	15,400	15,550	13,825	12,650	11,800	10,925	9,975
14,0	-	-	11,600	11,425	11,950	11,875	10,825	10,075	9,530	9,170
16,0	-	-	5,500	8,675	9,295	9,635	9,425	8,720	8,210	7,880
18,0	-	-	-	6,690	7,325	7,680	7,990	7,610	7,145	6,830
20,0	-	-	-	-	5,835	6,170	6,485	6,680	6,275	5,985
22,0	-	-	-	-	3,125	4,985	5,295	5,510	5,540	5,290
24,0	-	-	-	-	-	4,035	4,325	4,550	4,760	4,690
26,0	-	-	-	-	-	-	3,530	3,760	3,980	4,130
28,0	-	-	-	-	-	-	2,120	3,095	3,315	3,475
30,0	-	-	-	-	-	-	-	2,530	2,755	2,915
32,0	-	-	-	-	-	-	-	-	2,270	2,430
34,0	-	-	-	-	-	-	-	-	1,395	2,015
36,0	-	-	-	-	-	-	-	-	-	1,645

80005329

Load charts • Traglasten • Capacités de levage • Capacidades Capacità • Diagramas de carga • Таблицы грузоподъемности

Telescopic boom • Teleskopausleger • Flèche principale • Pluma telescópica • Braccio telescopico
Lança telescópica • Телескопическая стрела



m	12,6	15,2	18,3	21,4	24,4	27,4	30,5	33,5	36,6	39,0
3,0	67,350	56,225	47,850	-	-	-	-	-	-	-
3,5	59,950	56,225	47,850	-	-	-	-	-	-	-
4,0	53,375	52,675	47,325	26,975	-	-	-	-	-	-
4,5	47,450	44,850	40,850	26,975	19,075	-	-	-	-	-
5,0	41,425	38,075	34,925	26,975	19,075	19,050	-	-	-	-
6,0	31,000	28,850	26,700	24,850	19,075	19,050	17,975	-	-	-
7,0	24,400	22,825	21,275	19,900	19,075	19,050	17,975	14,475	-	-
8,0	19,475	18,600	17,425	16,325	16,175	15,950	15,675	14,475	11,675	9,975
9,0	15,525	15,225	14,500	13,650	13,625	13,525	13,375	13,175	11,675	9,975
10,0	12,625	12,475	12,225	11,525	11,625	11,600	11,525	11,400	11,250	9,975
12,0	-	8,710	8,625	8,410	8,645	8,760	8,785	8,770	8,715	8,665
14,0	-	-	6,155	6,005	6,530	6,720	6,840	6,880	6,880	6,875
16,0	-	-	4,420	4,250	4,820	5,190	5,355	5,460	5,500	5,525
18,0	-	-	-	2,950	3,545	3,885	4,200	4,335	4,415	4,470
20,0	-	-	-	-	2,560	2,880	3,190	3,405	3,530	3,605
22,0	-	-	-	-	1,780	2,085	2,375	2,595	2,800	2,885
24,0	-	-	-	-	-	1,435	1,715	1,935	2,145	2,290
26,0	-	-	-	-	-	-	1,170	1,390	1,600	1,750
28,0	-	-	-	-	-	-	0,710	0,930	1,145	1,295
30,0	-	-	-	-	-	-	-	0,540	0,750	0,905
32,0	-	-	-	-	-	-	-	-	-	0,570

AG-829-103677



m	12,6	15,2	18,3	21,4	24,4	27,4	30,5	33,5	36,6	39,0
3,0	39,875	36,000	32,400	-	-	-	-	-	-	-
3,5	32,500	29,675	26,950	-	-	-	-	-	-	-
4,0	27,175	25,050	22,875	21,025	-	-	-	-	-	-
4,5	23,150	21,450	19,725	18,175	17,675	-	-	-	-	-
5,0	20,000	18,600	17,200	15,900	15,550	15,150	-	-	-	-
6,0	15,425	14,375	13,350	12,425	12,300	12,125	11,875	-	-	-
7,0	12,275	11,400	10,600	9,900	9,955	9,885	9,775	9,630	-	-
8,0	9,955	9,220	8,545	7,955	8,130	8,170	8,140	8,065	7,960	7,870
9,0	7,870	7,525	6,940	6,440	6,670	6,795	6,835	6,815	6,760	6,710
10,0	6,235	6,110	5,660	5,220	5,495	5,660	5,765	5,795	5,770	5,750
12,0	-	3,940	3,750	3,385	3,710	3,930	4,090	4,190	4,245	4,265
14,0	-	-	2,365	2,070	2,425	2,675	2,865	3,000	3,085	3,145
16,0	-	-	1,275	1,090	1,455	1,725	1,935	2,090	2,195	2,270
18,0	-	-	-	-	0,705	0,980	1,200	1,370	1,490	1,575
20,0	-	-	-	-	-	-	0,615	0,790	0,920	1,010
22,0	-	-	-	-	-	-	-	-	-	0,545

AG-829-103678

Load charts • Traglasten • Capacités de levage • Capacidades Caracità • Diagramas de carga • Таблицы грузоподъемности



12,6 – 39,0 m



0 km/h



360°



8,2 t



DIN/ISO

m	12,6	15,2	18,3	21,4	24,4	27,4
3,5	22,300	18,475	-	-	-	-
4,0	20,650	17,625	-	-	-	-
4,5	17,725	16,300	-	-	-	-
5,0	15,000	14,200	-	-	-	-
6,0	10,950	10,975	10,075	9,295	-	-
7,0	8,280	8,270	7,860	7,305	-	-
8,0	6,370	6,340	6,100	5,775	5,965	-
9,0	4,940	4,915	4,750	4,560	4,800	4,940
10,0	3,825	3,815	3,690	3,500	3,850	4,025
12,0	-	2,240	2,125	1,920	2,395	2,615
14,0	-	-	1,025	0,870	1,330	1,535
16,0	-	-	-	-	0,505	0,740

AG-829-103683



85 %

m	12,6	15,2	18,3	21,4	24,4	27,4
3,5	22,300	18,475	-	-	-	-
4,0	21,100	17,625	-	-	-	-
4,5	19,325	16,375	-	-	-	-
5,0	17,375	14,800	-	-	-	-
6,0	12,775	12,250	12,025	9,985	-	-
7,0	9,760	9,780	9,335	9,340	-	-
8,0	7,600	7,595	7,345	7,400	7,250	-
9,0	5,985	5,985	5,825	5,700	6,145	5,530
10,0	4,725	4,745	4,625	4,425	4,990	5,240
12,0	-	2,955	2,855	2,640	3,235	3,395
14,0	-	-	1,550	1,455	1,965	2,150
16,0	-	-	-	-	1,010	1,255

AG-829-0103679

Load charts • Traglasten • Capacités de levage • Capacidades Capacità • Diagramas de carga • Таблицы грузоподъемности

Telescopic boom • Teleskopausleger • Flèche principale • Pluma telescópica • Braccio telescopico
Lança telescópica • Телескопическая стрела



12,6 – 39,0 m



4 km/h



0°



8,2 t



DIN/ISO

m	12,6	15,2	18,3	21,4	24,4	27,4
3,5	26,950	22,400	-	-	-	-
4,0	25,300	22,400	-	-	-	-
4,5	22,875	22,400	-	-	-	-
5,0	21,050	20,900	-	-	-	-
6,0	17,550	17,425	16,725	13,475	-	-
7,0	15,050	14,925	14,550	13,475	-	-
8,0	12,375	12,200	11,950	11,975	-	-
9,0	9,945	9,745	9,600	9,750	10,050	-
10,0	8,125	7,915	7,830	7,940	8,280	-
12,0	-	5,370	5,365	5,370	5,780	6,130
14,0	-	-	3,735	3,665	4,090	4,425
16,0	-	-	2,575	2,455	2,885	3,190
18,0	-	-	-	1,550	1,985	2,265
20,0	-	-	-	-	1,290	1,550
22,0	-	-	-	-	0,730	0,980
24,0	-	-	-	-	-	0,510

AG-82P-103684



85 %

m	12,6	15,2	18,3	21,4	24,4	27,4
3,5	26,950	22,400	-	-	-	-
4,0	25,300	22,400	-	-	-	-
4,5	22,875	22,400	-	-	-	-
5,0	21,050	20,900	-	-	-	-
6,0	17,550	17,425	16,725	13,475	-	-
7,0	15,050	14,925	14,550	13,475	-	-
8,0	12,950	12,800	12,600	12,800	-	-
9,0	11,200	11,025	10,900	11,075	11,100	-
10,0	9,780	9,625	9,560	9,675	9,990	-
12,0	-	7,240	7,265	7,285	7,745	8,100
14,0	-	-	4,100	4,040	5,505	5,905
16,0	-	-	2,975	2,870	3,340	3,670
18,0	-	-	-	1,925	2,420	2,730
20,0	-	-	-	-	1,665	1,960
22,0	-	-	-	-	1,040	1,330
24,0	-	-	-	-	-	0,790

AG-82P-103680

Load charts • Traglasten • Capacités de levage • Capacidades Caracità • Diagramas de carga • Таблицы грузоподъемности

Swingaway • Klappspitze • Extension treillis • Plumín • Falcone • Swingaway • Складной удлинитель стрелы



12,6 - 39,0 m



10,0 - 29,2 m



100 %



360°



8,2 t



DIN / ISO

m	10,0 m			17,0 m		
	0°	20°	40°	0°	20°	40°
10,0	5,395	-	-	-	-	-
12,0	5,395	-	-	2,745	-	-
14,0	5,395	5,285	-	2,745	-	-
16,0	5,395	4,620	4,080	2,745	-	-
18,0	5,065	4,155	3,640	2,745	2,450	-
20,0	4,490	3,760	3,345	2,745	2,400	-
22,0	4,020	3,420	3,085	2,710	2,340	2,070
24,0	3,620	3,130	2,855	2,650	2,280	2,010
26,0	3,275	2,875	2,650	2,515	2,100	1,860
28,0	2,980	2,655	2,475	2,270	1,930	1,725
30,0	2,725	2,455	2,310	2,060	1,775	1,605
32,0	2,290	2,280	2,160	1,870	1,635	1,495
34,0	1,900	2,095	2,030	1,710	1,510	1,395
36,0	1,555	1,720	1,810	1,560	1,400	1,305
38,0	1,250	1,385	-	1,430	1,290	1,220
40,0	0,975	1,085	-	1,185	1,200	1,135
42,0	0,725	0,820	-	0,945	1,115	1,065
44,0	0,505	-	-	0,725	0,920	-
46,0	-	-	-	0,525	0,695	-

AG-829-0103696

m	23,1 m			29,2 m		
	0°	20°	40°	0°	20°	40°
16,0	2,200	-	-	-	-	-
18,0	2,200	-	-	1,595	-	-
20,0	2,200	2,220	-	1,595	-	-
22,0	2,200	2,125	-	1,595	1,695	-
24,0	2,155	1,905	1,835	1,595	1,585	-
26,0	1,945	1,710	1,580	1,485	1,395	1,460
28,0	1,730	1,540	1,440	1,295	1,235	1,195
30,0	1,540	1,395	1,310	1,120	1,085	1,060
32,0	1,375	1,255	1,190	0,970	0,950	0,935
34,0	1,230	1,135	1,085	0,840	0,835	0,830
36,0	1,100	1,025	0,985	0,720	0,725	0,730
38,0	0,985	0,925	0,895	0,615	0,630	0,635
40,0	0,880	0,835	0,815	0,520	0,540	0,550
42,0	0,785	0,745	0,735	-	-	-
44,0	0,700	0,670	0,665	-	-	-
46,0	0,545	0,595	0,595	-	-	-
48,0	-	0,530	0,535	-	-	-

AG-829-0103699 C







85 %



m	10,0 m			17,0 m		
	0°	20°	40°	0°	20°	40°
10,0	5,395	-	-	-	-	-
12,0	5,395	-	-	2,745	-	-
14,0	5,395	5,285	-	2,745	-	-
16,0	5,395	4,620	4,140	2,745	-	-
18,0	5,065	4,155	3,640	2,745	2,745	-
20,0	4,490	3,760	3,345	2,745	2,665	-
22,0	4,020	3,420	3,085	2,745	2,520	2,210
24,0	3,620	3,130	2,855	2,740	2,295	2,010
26,0	3,275	2,875	2,650	2,515	2,100	1,860
28,0	2,980	2,655	2,475	2,270	1,930	1,725
30,0	2,725	2,455	2,310	2,060	1,775	1,605
32,0	2,500	2,280	2,160	1,870	1,635	1,495
34,0	2,300	2,120	2,030	1,710	1,510	1,395
36,0	2,020	1,980	1,915	1,560	1,400	1,305
38,0	1,690	1,815	-	1,430	1,290	1,220
40,0	1,400	1,495	-	1,310	1,200	1,135
42,0	1,135	1,215	-	1,205	1,115	1,065
44,0	0,900	-	-	1,110	1,035	-
46,0	-	-	-	0,910	0,960	-

AG-829-0103695

Load charts • Traglasten • Capacités de levage • Capacidades Capacità • Diagramas de carga • Таблицы грузоподъемности





Swingaway • Klappspitze • Extension treillis • Plumín • Falcone • Swingaway • Складной удлинитель стрелы



 12,6 - 39,0 m
  10,0 - 29,2 m
  100 %
  360°
  8,2 t

  85 %

m	23,1 m			29,2 m		
	0°	20°	40°	0°	20°	40°
16,0	2,200	-	-	-	-	-
18,0	2,200	-	-	1,595	-	-
20,0	2,200	2,375	-	1,595	-	-
22,0	2,200	2,125	-	1,595	1,695	-
24,0	2,155	1,905	1,835	1,595	1,585	-
26,0	1,945	1,710	1,580	1,485	1,395	1,460
28,0	1,730	1,540	1,440	1,295	1,235	1,195
30,0	1,540	1,395	1,310	1,120	1,085	1,060
32,0	1,375	1,255	1,190	0,970	0,950	0,935
34,0	1,230	1,135	1,085	0,840	0,835	0,830
36,0	1,100	1,025	0,985	0,720	0,725	0,730
38,0	0,985	0,925	0,895	0,615	0,630	0,635
40,0	0,880	0,835	0,815	0,520	0,540	0,550
42,0	0,785	0,745	0,735	-	-	-
44,0	0,700	0,670	0,665	-	-	-
46,0	0,620	0,595	0,595	-	-	-
48,0	0,550	0,530	0,535	-	-	-

AG-825-0-103/018 C

 12,6 - 39,0 m
  10,0 - 29,2 m
  50 %
  360°
  8,2 t

  85 %

m	10,0 m			17,0 m		
	0°	20°	40°	0°	20°	40°
10,0	5,395	-	-	-	-	-
12,0	5,395	-	-	2,745	-	-
14,0	5,395	5,285	-	2,745	-	-
16,0	5,300	4,620	4,080	2,745	-	-
18,0	4,325	4,155	3,640	2,745	2,450	-
20,0	3,530	3,760	3,345	2,745	2,400	-
22,0	2,880	3,305	3,085	2,710	2,340	2,070
24,0	2,330	2,710	2,855	2,430	2,280	2,010
26,0	1,865	2,200	2,460	1,975	2,100	1,860
28,0	1,465	1,760	1,985	1,585	1,930	1,725
30,0	1,115	1,380	1,570	1,245	1,720	1,605
32,0	0,810	1,045	1,200	0,945	1,375	1,495
34,0	0,540	0,745	0,875	0,675	1,065	1,375
36,0	-	-	0,580	-	0,790	1,055
38,0	-	-	-	-	0,540	0,770
40,0	-	-	-	-	-	0,505

AG-825-0-103/017

Load charts • Traglasten • Capacités de levage • Capacidades Capacità • Diagramas de carga • Таблицы грузоподъемности

Weight reductions • Gewichtsreduzierung durch Lastaufnahmemittel • Reductions de charge
Reducciones de peso • Riduzioni di peso • Reduções de peso • Снижение веса

Auxiliary boom nose / Zusatz-Auslegerkopf / Tête de flèche auxiliaire / Cabeza auxiliar / Falconcino ausiliario in testa al braccio / Cabeçote da lança auxiliar / Вспомогательный оголовок стрелы	62 kg
Hookblocks / Hakenflaschen / Moufles / Ganchos / Ganci / Cadernais / Крюковой блок	
75 tonne 5 sheave / Seilrollen / Réas / Poleas / Carrucole / Roldanas / блок	578 kg
36 tonne 3 sheave / Seilrollen / Réas / Poleas / Carrucole / Roldanas / блок	545 kg
9,1 tonne overhaul ball / 9,1 t Kugelhaken / Crochet simple de 9,1 tonnes / Ganho de bola de 9,1 toneladas / Bozzello a palla da 9,1 tonnellate / Bola e gancho de 9,1 toneladas / 9,1-крюк с шаром утяжелителем	258 kg
10-17 m bifold swingaway fly jib / Doppelklappspitze / Extension de flèche repliable / Plumín Plegable / Prolunga ripiegabile del braccio / Extensão da lança articulada. / складной удлинитель стрелы	
10 m erected / Klappspitze vorgebaut / Déplié / Montado / Montato / Montado / смонтированный	1 678 kg
17 m erected / Klappspitze vorgebaut / Déplié / Montado / Montato / Montado / смонтированный	3 552 kg
23,1 m jib erected / Spitze vorgebaut / Déplié / Montado / Montato / Montado / смонтированный	4 695 kg
29,2 m jib erected / Spitze vorgebaut / Déplié / Montado / Montato / Montado / смонтированный	6 033 kg

Note: All load handling devices and boom attachments are considered part of the load and suitable allowances must be made for their combined weights.

Hinweis: Alle Lastaufnahmemittel und jede Zusatzausrüstung des Hauptauslegers werden als Teil der Traglast betrachtet und ihre kombinierten Gewichte müssen beim Feststellen der Nettolast entsprechend berücksichtigt (abgezogen) werden.

Remarque : Les équipements complémentaires et accessoires de levage sont considérés comme faisant partie de la charge; les réductions de charges de leurs poids combinés doivent être effectuées.

Nota: Todos los aparos de elevacion e implementos de pluma son considerados parte de la carga y deben ser tenidos en cuenta para calcular los pesos a elevar.

Nota: Tutti gli accessori di sollevamento e le opzioni montate sul braccio sono considerati parte del carico e devono essere richieste adeguate autorizzazioni per l'uso dei loro pesi complessive.

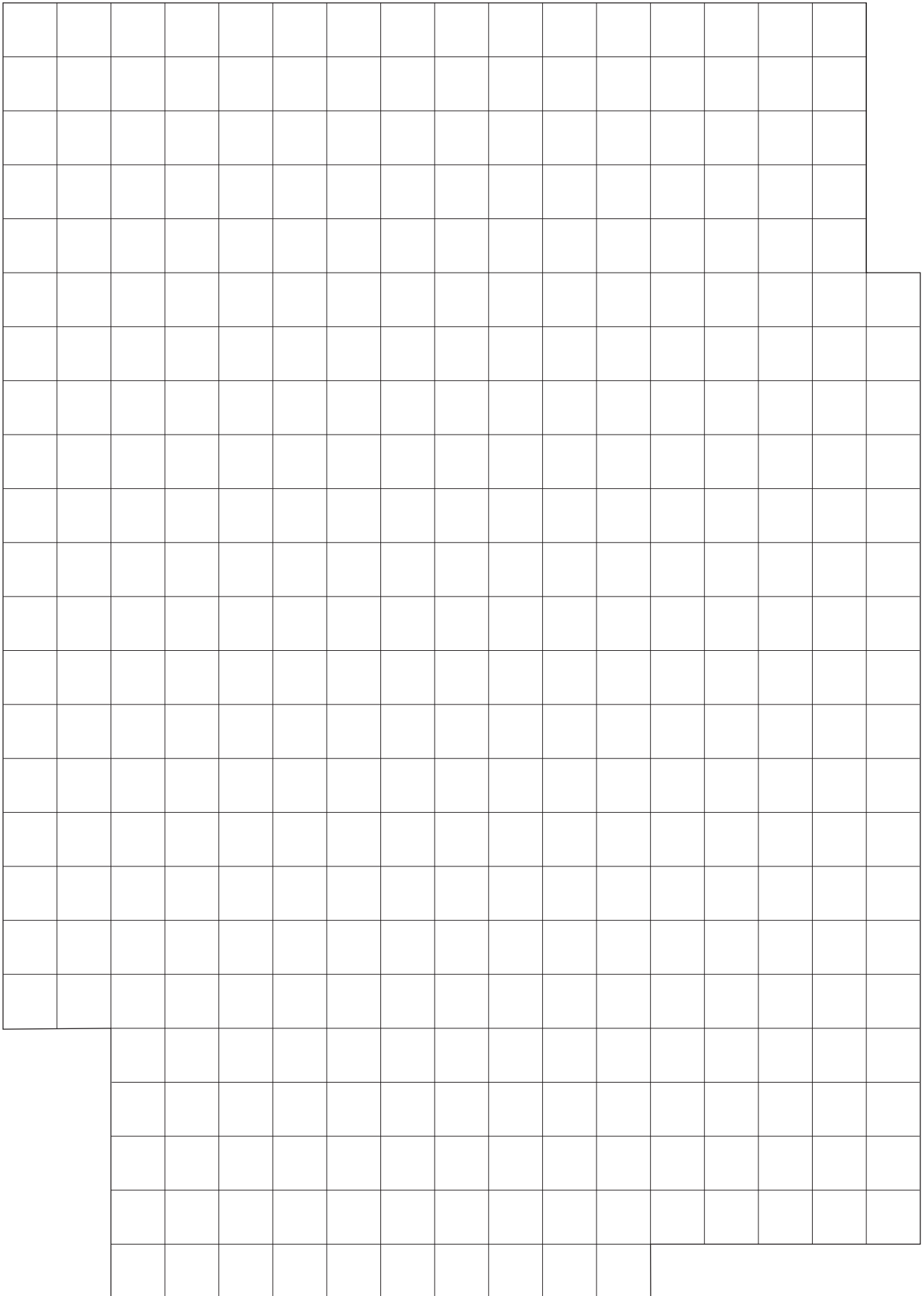

Nota: Todos os acessórios de elevação e opcionais de lança contribuem para a carga a elevar pelo que devem ser tidos em conta nos cálculos dos pesos a elevar

Примечание: Все погрузочно/разгрузочные устройства и дополнительные приспособления стрелы считаются частью нагрузки, поэтому в общем весе для них нужно учитывать некоторые допущения.



Notes • Hinweise • Notes • Notas • Note • Примечания

Symbols • Symbolerklärung • Glossaire des symboles • Glosario de simbolos • Glossario dei simboli • Simbolos • Символы

	Axles Achsen Ponts Ejes Assali Eixos Оси		Crane functions Kranbewegungen Mouvements de la grue Funciones de la grúa Funzioni della gru Funções da grua Функции крана		Hookblock / Capacity Hakenflasche / Traglast Moufle / Force de levage Gancho / Capacidad Gancio / Capacità Gancho / Capacidade Крюковой блок / Грузоподъемность		Speed Geschwindigkeit Vitesse Velocidad Velocità Velocidade СКОРОСТЬ
	Axle load Achslast Charge à l'essieu Carga por eje Carico sugli assi Carga por eixo Нагрузка на ось		Crane travel Fahrstellung Déplacement de la grue Grúa en traslado Traslazione gru Deslocação da grua Перемещение крана		Hydraulic system Hydrauliksystem Circuit hydraulique Sistema hidráulico Impianto idraulico Sistema hidráulico Гидравлическая система		Suspension Federung Suspension Suspensión Suspensio Suspensão Подвеска
	Boom Ausleger Flèche Pluma Braccio Lança Стрела		Drive/Steer Antrieb/Lenkung Direction/Déplacement Tracción/Dirección Trazione/Sterzo Tração / Direcção Ведущие/Управляемые оси		Lattice extension Gitterspitze Extension treillis Extensión de celosia Falcone tralicciato Extensão treliçada Гусек		Transmission / Gear Getriebe / Gang Boîte de vitesses / Rapport Transmisión / Cambio Cambio Transmissão / Mudança Трансмиссия / передача
	Boom elevation Wippwerk Relevage Elevacion de pluma Elevazione braccio Elevação da lança Подъем стрелы		Electrical system Elektrische Anlage Circuit électrique Sistema eléctrico Impianto elettrico Sistema eléctrico Электросистема		Lattice extension (luffing) Gitterspitze (wippbar) Extension treillis (volée variable) Extensión de celosia (angulable hidráulicamente) Falcone tralicciato (inclinabile) Extensão treliçada (angulação hidráulica) Гусек (с изменением вылета)		Travel speed Fahrgeschwindigkeit Vitesse de déplacement Velocidad de desplazamiento Velocità di traslazione Velocidade de translação СКОРОСТЬ ДВИЖЕНИЯ
	Boom telescoping Teleskopieren Télescopage de flèche Telescopaje de pluma Lunghezza braccio Telescopagem da lança Выдвижение стрелы		Engine Motor Moteur Motor Motore Motor Двигатель		Luffing Jib Wippspitzenausleger Volée variable Plumín angulable Falcone a volata variabile Jib angulável Маневровый гусек		Tyres Bereifung Pneumatiques Neumáticos Pneumatici Pneus ШИНЫ
	Brakes Bremsen Freins Frenos Freni Travões Тормоза		Free on wheels Freistehend Sur pneus Sobre neumáticos Su gomme - Sobre pneus Свободные внутренние колеса		Low range Kriechgang Gamme basse Marchas cortas Fuoristrada Marcha lenta Низкий диапазон		
	Cab Kabine Cabine Cabina Cabina Cabine Кабина		Gradeability Steigfähigkeit Aptitude en pente Superacion de pendientes Pendenza superabile Declive Преодолеваемый уклон		Outriggers Abstützung Calage Estabilizadores Stabilizzatori Estabilizadores Выносные опоры		
	Carrier frame Chassis-Rahmen Châssis porteur Bastidor Telaio Chassis Рама тягача		Main hoist Haupthubwerk Treuil principal Cabrestante principal Argano principale Guincho principal Лебедка основного подъема		Radius Ausladung Portée Radio Raggio Raio Вылет		
	Counterweight Gegengewicht Contrepoids Contrapeso Contrapeso - Contrapeso Противовес		Auxiliary hoist - Hilfshebwerk Treuil auxiliaire Cabrestante auxiliar Argano secundario Guincho auxiliar Лебедка вспомогательного подъема		Slewing/Working range Drehwerk/Arbeitsbereich Orientation/Rayon d'opération Giro/Gama de trabajo Rotazione/Area di lavoro - Giratória / Gama de trabalho Поворот/ Рабочий диапазон		

Regional headquarters

Manitowoc - Americas

Manitowoc, Wisconsin, USA

Tel: +1 920 684 6621

Fax: +1 920 683 6278

Shady Grove, Pennsylvania, USA

Tel: +1 717 597 8121

Fax: +1 717 597 4062

Manitowoc - Europe, Middle East & Africa

Ecully, France

Tel: +33 (0)4 72 18 20 20

Fax: +33 (0)4 72 18 20 00

Manitowoc - Asia Pacific

Shanghai, China

Tel: +86 21 6457 0066

Fax: +86 21 6457 4955

Regional offices

Americas

Brazil

Alphaville

Mexico

Monterrey

Chile

Santiago

Europe, Middle East & Africa

Algeria

Hydra

Czech Republic

Netvorice

France

Baudemont

Cergy

Decines

Germany

Langenfeld

Hungary

Budapest

Italy

Parabiago

Netherlands

Breda

Poland

Warsaw

Portugal

Baltar

Lisbon

Russia

Moscow

U.A.E.

Dubai

U.K.

Gawcott

Asia - Pacific

Australia

Brisbane

Melbourne

Sydney

China

Beijing

Xi'an

Korea

Seoul

India

Hyderabad

Pune

Philippines

Makati City

Singapore

Singapore

Factories

Brazil

Alphaville

China

TaiAn

Zhangjiagang

France

Charlieu

La Clayette

Moulins

Germany

Wilhelmshaven

India

Pune

Italy

Niella Tanaro

Portugal

Baltar

Fânzeres

Slovakia

Saris

USA

Manitowoc

Port Washington

Shady Grove

This document is non-contractual. Constant improvement and engineering progress make it necessary that we reserve the right to make specification, equipment, and price changes without notice. Illustrations shown may include optional equipment and accessories and may not include all standard equipment.

Die Angaben in diesem Dokument erfolgen ohne Gewähr. Wir verbessern unsere Produkte ständig und integrieren den technischen Fortschritt. Aus diesem Grund behalten wir uns das Recht vor, die technischen Daten, die Ausstattungsdetails und die Preise unserer Maschinen ohne Vorankündigung zu ändern.

Ce document est non-contractuel. Du fait de sa politique d'amélioration constante de ses produits liée au progrès technique, la Société se réserve le droit de procéder sans préavis à des changements de spécifications, d'équipement ou de prix. Les illustrations peuvent comporter des équipements ou accessoires optionnels ou ne pas comporter des équipements standards.

Este documento no es contractual. El perfeccionamiento constante y el avance tecnológico hacen necesario que la empresa se reserve el derecho de efectuar cambios en las especificaciones, equipo y precios sin previo aviso. En las ilustraciones se puede incluir equipo y accesorios opcionales y es posible que no se muestre el equipo normal.

Documento non contrattuale. In considerazione della sua politica di costante miglioramento dei prodotti connesso al progresso tecnico, la Società si riserva il diritto di modificare senza preavviso specifiche, equipaggiamenti o prezzi. Le illustrazioni possono contenere equipaggiamenti o accessori optional o non contenere equipaggiamenti standard.

Este documento não se reveste de qualquer carácter contratual. A introdução constante de melhorias e o progresso da engenharia tornam necessário reservarmos o direito de introduzir alterações nas características técnicas, no equipamento e no preço sem qualquer aviso prévio. As ilustrações aqui apresentadas podem incluir equipamento e acessórios adicionais, podendo não incluir todo o equipamento padrão.

Данный документ не является контрактным. Принимая во внимание необходимость постоянного совершенствования и модернизации мы оставляем за собой право изменять спецификации, конструкции и стоимость без предварительного уведомления. Приведенные иллюстрации могут содержать дополнительные компоненты и принадлежности, не входящие в стандартный комплект поставки оборудования.