



MLC300

Product Guide

ASME B30.5
Metric

Features

- 350 t capacity
- 300 t capacity VPC-MAX™
- 2145 t-m maximum load moment
- 4119 t-m maximum load moment with VPC-MAX
- 102 m B10:500 boom
- 120 m B60:500 Boom with VPC-MAX™
- 42 m No. 148 fixed jib on B10:500 boom
- 96 m LJ10:501 luffing jib on B10:500 boom

MANITOWOC MLC300

The MLC300 combines class-leading load charts with a reduced footprint thanks to its revolutionary VPC technology. This delivers jobsite versatility and outstanding lifting capacity to maximize ROI.

Features

> Crane Control System

The Crane Control System offers a user-friendly interface, two full graphic displays mounted horizontally for better visibility, a jog dial for easier data input and ergonomic joysticks.



> Variable Position Counterweight (VPC)

The Manitowoc MLC300 features a counterweight system which automatically positions the crane's counterweight as required to match lifting demands. Crane lifting capability is optimized by automatic positioning of the counterweight; eliminating the need for carbody counterweight. Additionally, counterweight boxes are designed to be common across multiple crane platforms and are utilized on Manitowoc Model MLC650 as well as future new models.



> VPC-MAX

Capacity and boom and jib combination lengths can be increased through addition of the exclusive VPC-MAX attachment. The VPC-MAX attachment, utilizing all of the standard VPC components, increases the max load moment of the MLC300 when a 30 m fixed mast, VPC-MAX counterweight beam. The position of the VPC-MAX counterweight is automatically positioned based on lifted load, boom length or boom and jib length and load radius.

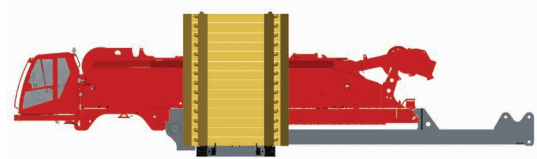

> FACT™ Connectors

Manitowoc's Fast Aligning Connection Technology (FACT™) automatically aligns crane components for fast, easy assembly.

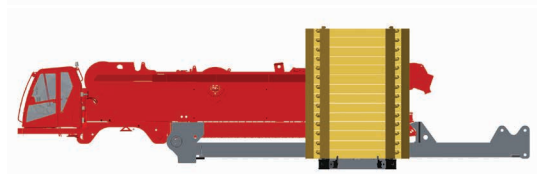

CraneSTAR®

> CraneSTAR is an exclusive and innovative crane asset management system

that helps improve your profitability and reduce costs by remotely monitoring critical crane data.

Visit www.cranestar.com for more information.

Jobsite benefits

Transportation

The MLC300 is designed to be transported globally with optimized component weights and dimensions. The MLC300 features a removable live mast shipping module and boom inserts designed to allow luffing jib inserts to ship within the boom inserts for cost effective transport.

Rugged durability and ease of service

The MLC300 comes equipped with numerous upgrades to spend less time performing maintenance.

- Individual function hour tracking to optimize service intervals
- Remote mounted filters for easy access inside enclosures

Easy and quick assembly

The MLC300 helps you spend less time on the truck and more time on the job.

- Raise full boom and luffing jib combinations without assist
- Self-erect mast cylinder eliminates need to reeve self assembly block

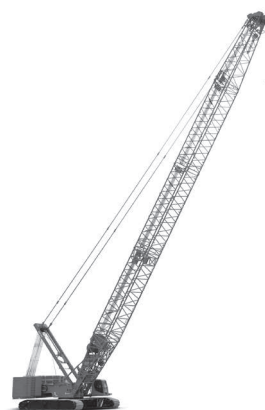

Manitowoc Crane Care when you need it.
The assurance of the world's most advanced crane service and support to get you back to work fast.



Manitowoc Finance helps you get right to work generating profits for your business.
Financial tools that help you capitalize on opportunity with solutions that fit your needs.

Contents

Outline dimensions	5
Transport data	10
Assembly	11
Performance data.....	13
Boom combinations	15
Working range/load charts - Main boom.....	16
Working range/load charts -Fixed jib	18
Working range/ load charts - Luffing jib	23
Boom combinations -VPC-MAX™	26
Working range/load charts - Main boom - VPC-MAX™	27
Working range/load charts - Fixed jib - VPC-MAX™	29
Working range/ load charts - Luffing jib - VPC-MAX™	32
Specifications.....	35

Outline dimensions

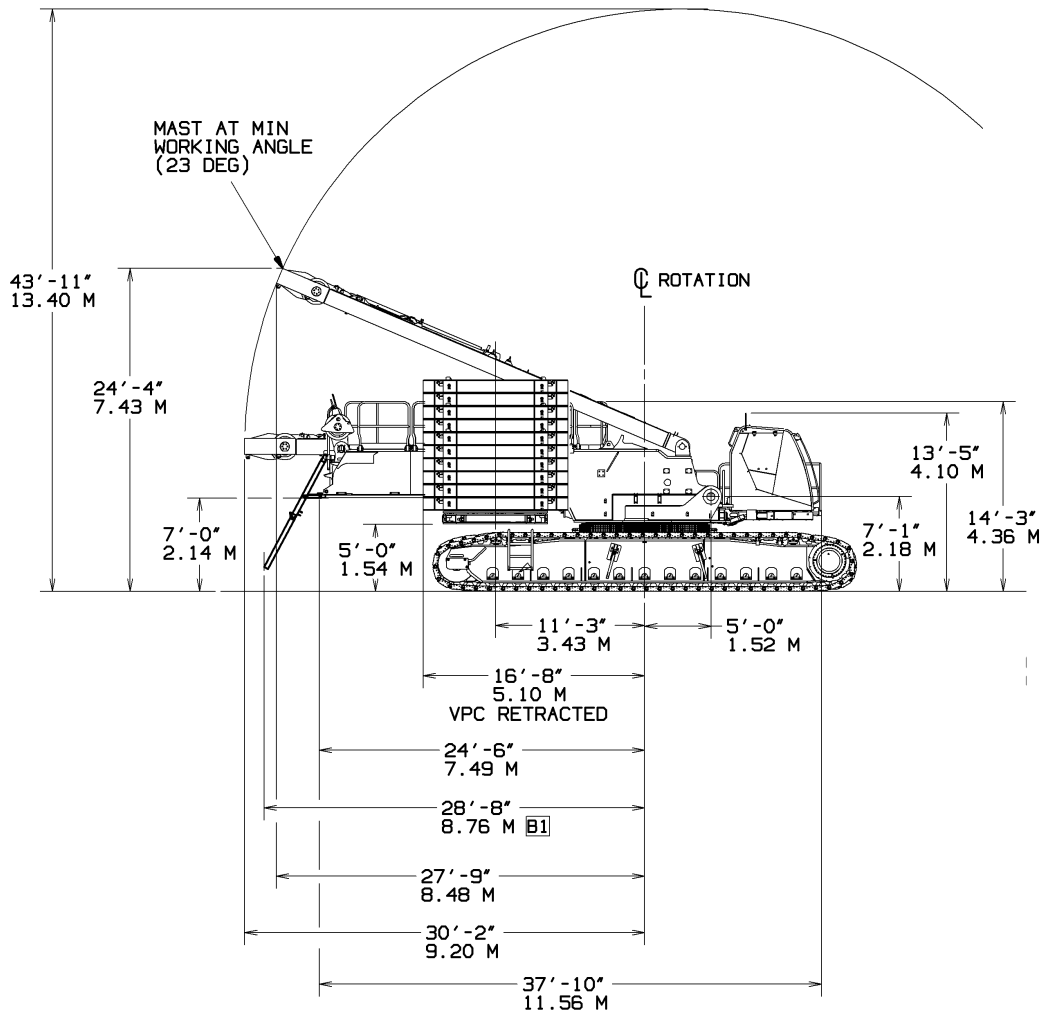

COUNTERWEIGHT HEIGHTS	
SERIES 3	16'-1" (4.93m)
SERIES 2	14'-2" (4.33m)
SERIES 1	12'-2" (3.73m)

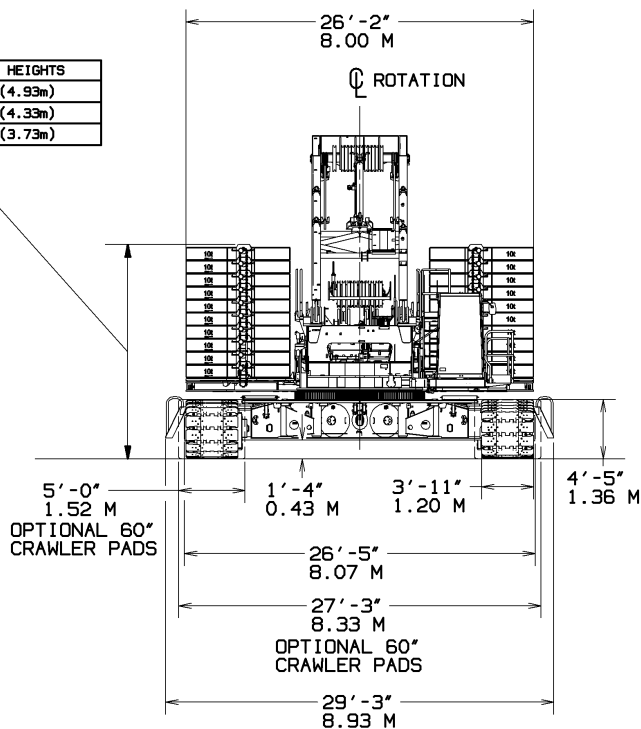

Outline dimensions

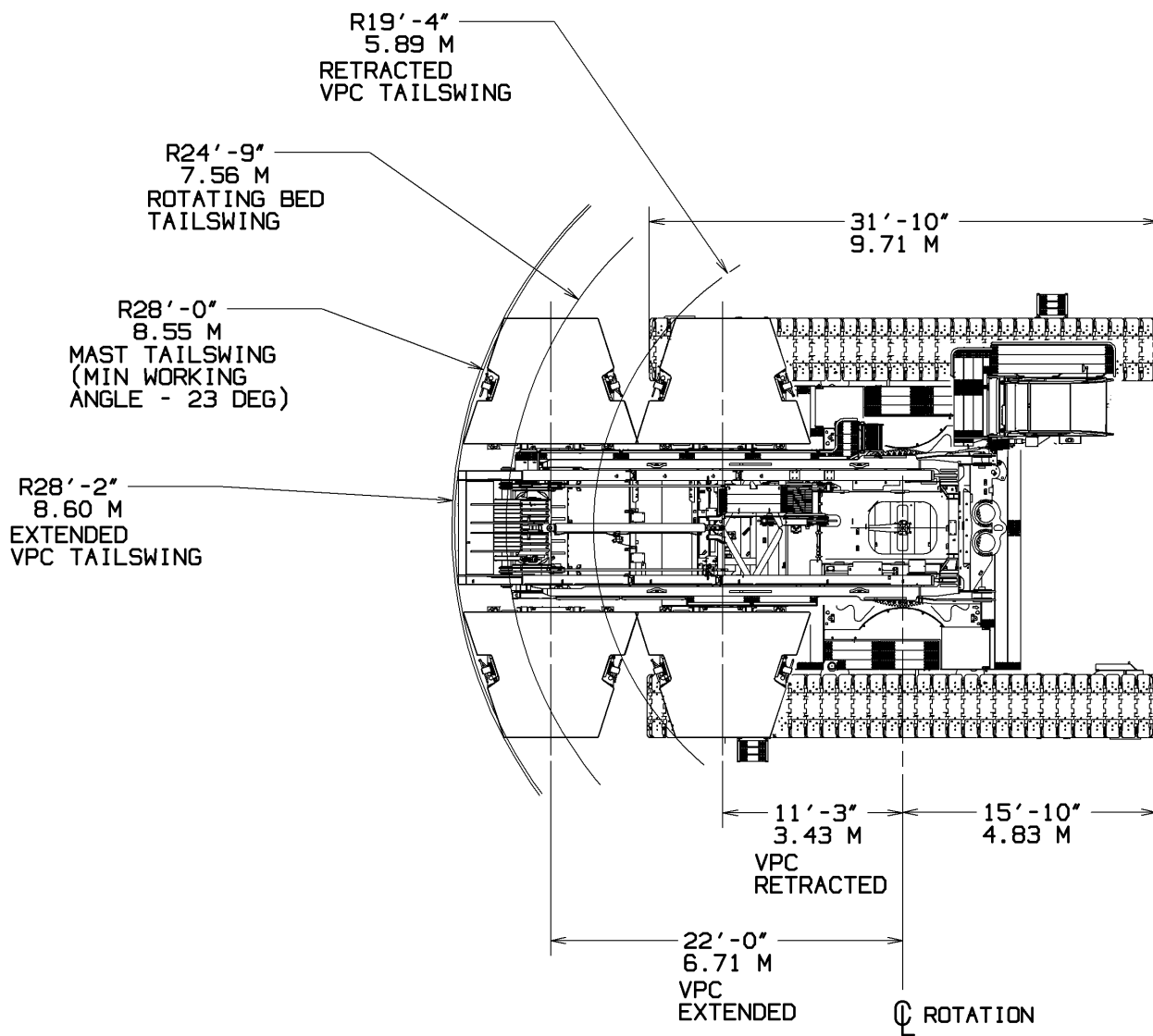

Outline dimensions

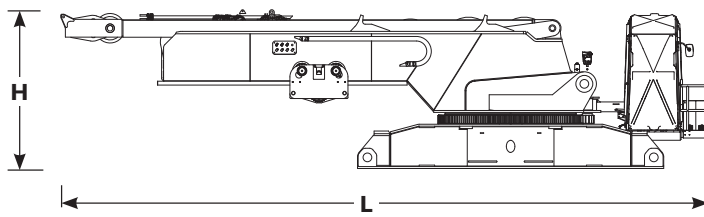

Rotating bed assembly	
Length	13,7 m
Width	3,0 m
Height	3,2 m
Weight	54 800 kg

Note: includes live mast, boom hoist, carbody jacks.

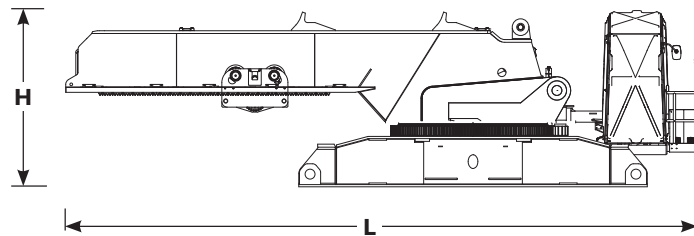

Rotating bed assembly	
Length	11,6 m
Width	3,0 m
Height	3,2 m
Weight	45 800 kg

Note: includes boom hoist, carbody jacks.

Note: excludes live mast, boom hoist

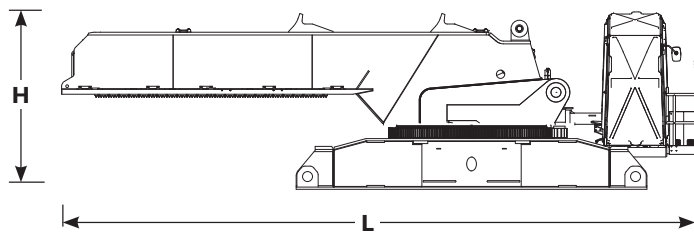

Rotating bed assembly	
Length	11,6 m
Width	3,0 m
Height	3,2 m
Weight	42 600 kg

Note: includes carbody jacks.

Note: excludes live mast, boom hoist and VPC trolley.

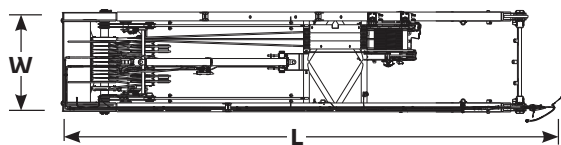

Live Mast Assembly	
Length	10,3 m
Width	2,3 m
Height	1,8 m
Weight	9000 kg

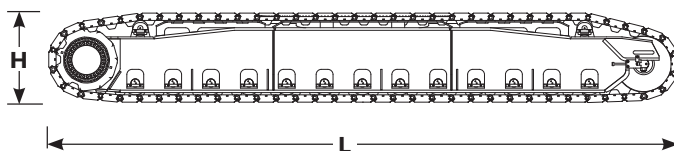

Crawlers	
Length	9,7 m
Width	1,2 m
Height	1,3 m
Weight	22 700 kg

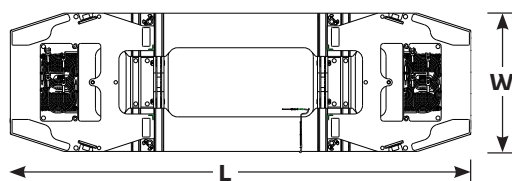

Counterweight tray	
Length	7,9 m
Width	2,4 m
Height	4,0 m
Weight	12 200 kg

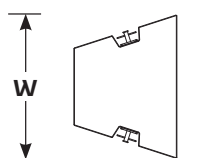

Counterweight box	
Length	2,4 m
Width	3,3 m
Height	0,4 m
Weight	10 000 kg

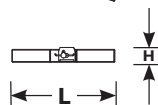

8 m No. 500 boom butt	
Length	8,4 m
Width	2,9 m
Height	2,5 m
Weight	16 400 kg

Note: includes main hoist, luffing/auxillary hoist, rigging winch and spring boom stop.

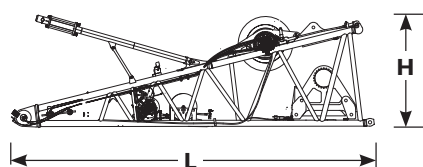

Outline dimensions

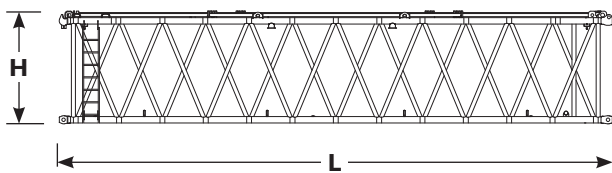

12 m No. 500 main boom heavy insert	
Length	12 m
Width	2,9 m
Height	2,5 m
Weight	5600 kg

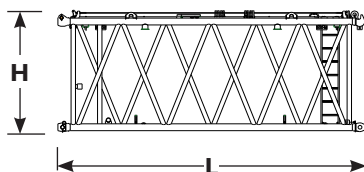

6 m No. 500 main boom medium insert	
Length	6,2 m
Width	3,0 m
Height	2,5 m
Weight	2400 kg

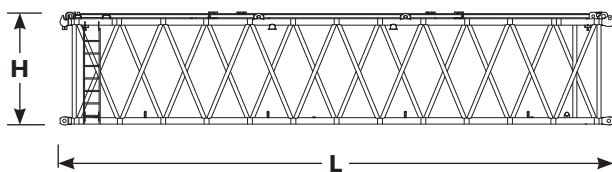

12 m No. 500 main boom medium insert with equalizer brackets	
Length	12,2 m
Width	3,0 m
Height	2,5 m
Weight	4500 kg

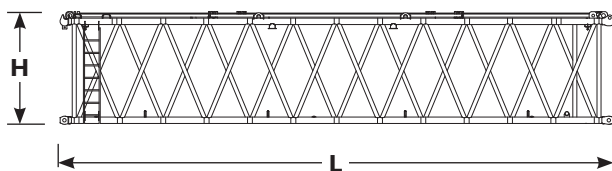

12 m No. 500 main boom medium insert	
Length	12,2 m
Width	3,0 m
Height	2,5 m
Weight	3800 kg

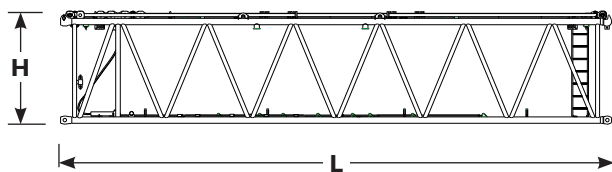

12m No. 500 main boom light insert with suspension	
Length	12,2 m
Width	3,0 m
Height	2,5 m
Weight	3800 kg

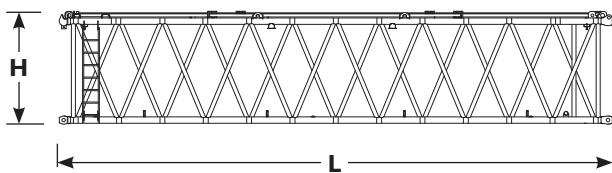

12m No. 500 main boom light insert	
Length	12,2 m
Width	3,0 m
Height	2,5 m
Weight	3500 kg

Outline dimensions

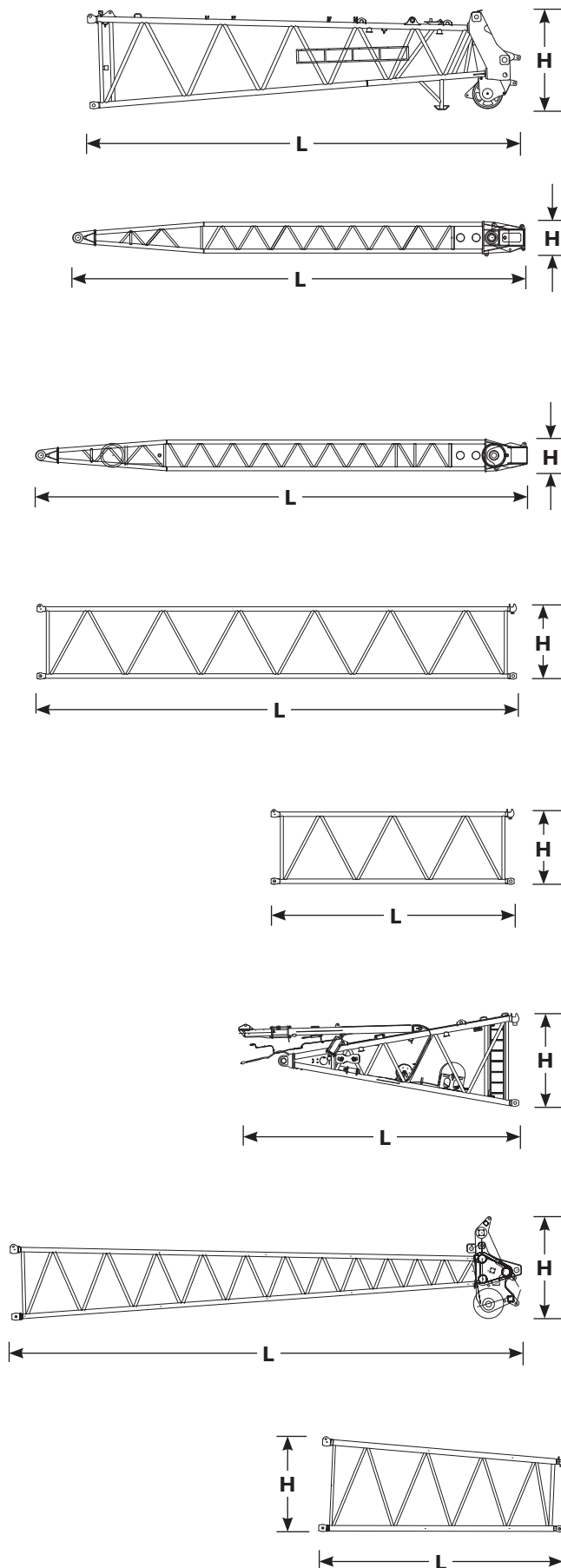

10 m No. 500 boom top

Length	11 m
Width	2,9 m
Height	2,6 m
Weight	8100 kg

10 m No. 501 luffing jib main strut

Length	11,5 m
Width	2,1 m
Height	0,9 m
Weight	3300 kg

Note: Sheaves, Straps, Wire rope guide, Main Strut stops are included

11 m No. 501 luffing jib strut

Length	12,5 m
Width	1,7 m
Height	0,8 m
Weight	4800 kg

Note: Sheaves, Straps, Wire rope guide are included

12 m No. 501 luffing jib insert

Length	12,1 m
Width	2,6 m
Height	1,9 m
Weight	2300 kg

Note: Jib Straps are included

6 m No. 501 luffing jib insert

Length	6,1 m
Width	2,6 m
Height	1,9 m
Weight	1300 kg

Note: Jib straps are included

6m No. 500A luffing jib butt

Length	6,3 m
Width	2,6 m
Height	2,4 m
Weight	3200 kg

Note: Jib stops and hinge pins are included

12 m No. 501 luffing jib top

Length	13 m
Width	2,6 m
Height	2,6 m
Weight	5300 kg

Note: Jib straps, lower point, and wire rope guide are included are included

6 m No. 500-501 transition insert

Length	6,2 m
Width	3,0 m
Height	2,5 m
Weight	2200 kg

Note: Jib straps are included

Transport data

Load summary																			
Item	78 m B10:500 heavy lift main boom + 12 m No. 148 fixed jib Series 2 counterweight Quantity on trailer load # (Does not include blocking, strapping, etc.)																		
	Qty	Weight kgs	1	2	3	4	5	6	7	8	9	10	11	12	13	14	15	16	17
Upperworks module	1	42 600	1	-	-	-	-	-	-	-	-	-	-	-	-	-	-	-	-
Crawler Assembly	2	22 400	-	1	1	-	-	-	-	-	-	-	-	-	-	-	-	-	-
8m No. 500 Boom butt	1	17 200	-	-	-	1	-	-	-	-	-	-	-	-	-	-	-	-	-
Counterweight tray	1	12 200	-	-	-	-	1	-	-	-	-	-	-	-	-	-	-	-	-
Upper counterweight box	16	10 000	-	-	-	-	1	-	1	1	1	1	1	1	1	2	2	2	2
Mast shipping module	1	9000	-	-	-	-	-	1	-	-	-	-	-	-	-	-	-	-	-
VPC™ Actuator	1	3200	-	-	-	-	-	1	-	-	-	-	-	-	-	-	-	-	-
12 m No. 500 Heavy Insert w/sheaves	1	5600	-	-	-	-	-	-	1	-	-	-	-	-	-	-	-	-	-
12 m No. 500 Medium Insert	3	3800	-	-	-	-	-	-	-	1	1	1	-	-	-	-	-	-	-
12 m No. 500 Light Insert w/ Suspension	1	3800	-	-	-	-	-	-	-	-	-	-	1	-	-	-	-	-	-
10 m No. 500 Boom top	1	8100	-	-	-	-	-	-	-	-	-	-	-	1	-	-	-	-	-
12 m No. 148 Fixed jib assembly	1	51 000	-	-	-	-	-	-	-	-	-	-	-	-	1	-	-	-	-
220 t Block	1	3200	-	-	-	-	-	-	-	1	-	-	-	-	-	-	-	-	-
100 t Block	1	1900	-	-	-	-	-	-	-	-	1	-	-	-	-	-	-	-	-
Weight ball	1	700	-	-	-	-	-	-	-	-	-	1	-	-	-	-	-	-	-
Misc. job box	2	900	-	-	-	-	-	-	-	-	-	-	1	-	1	-	-	-	-
Misc. job box			42 600	22 400	22 400	17 200	22 200	12 200	15 600	17 000	15 700	14 500	14 700	18 100	16 000	20 000	20 000	20 000	20 000

Assembly

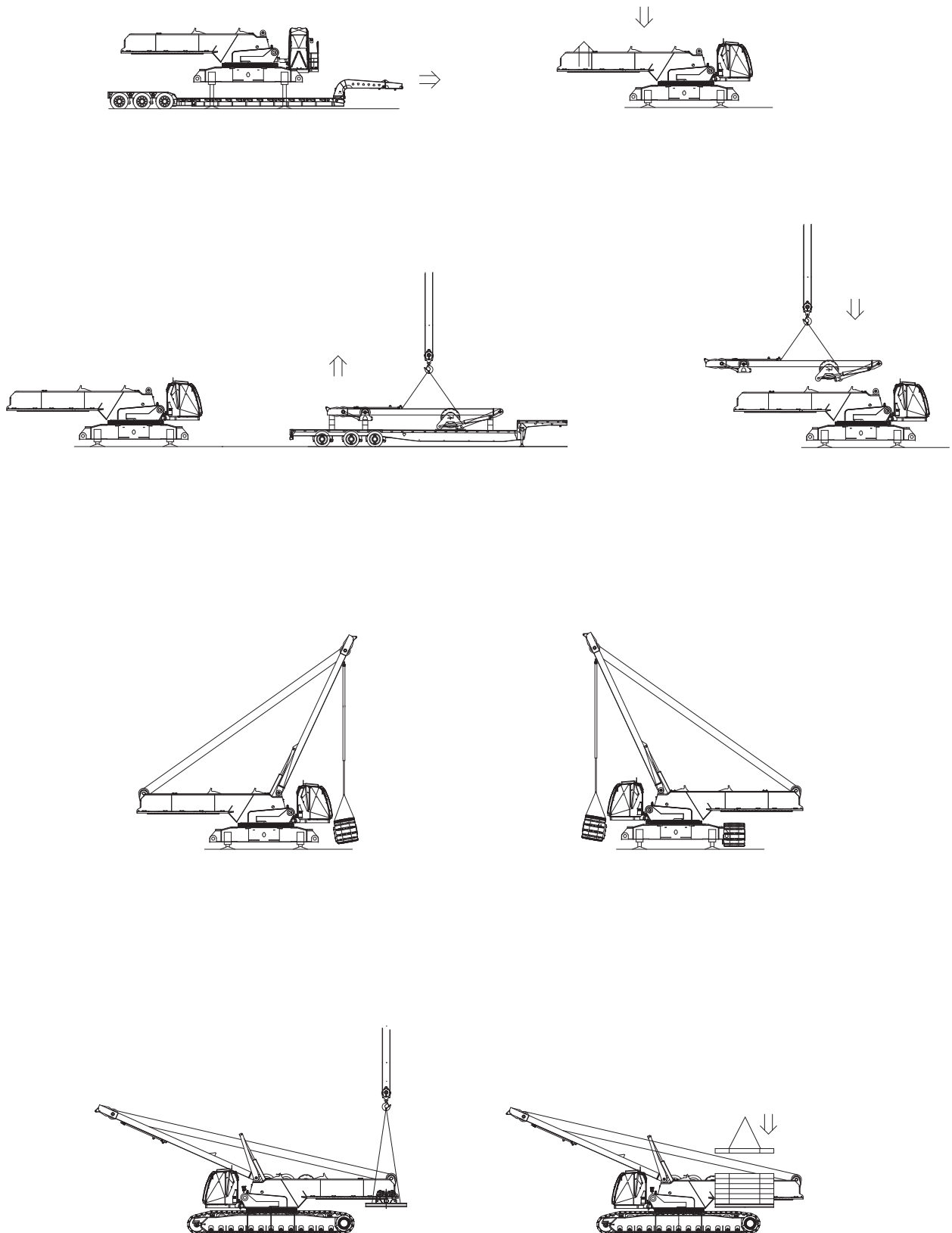

Assembly

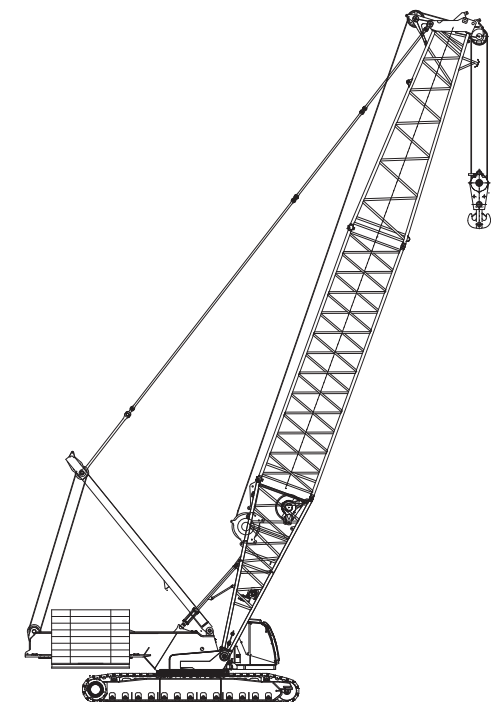
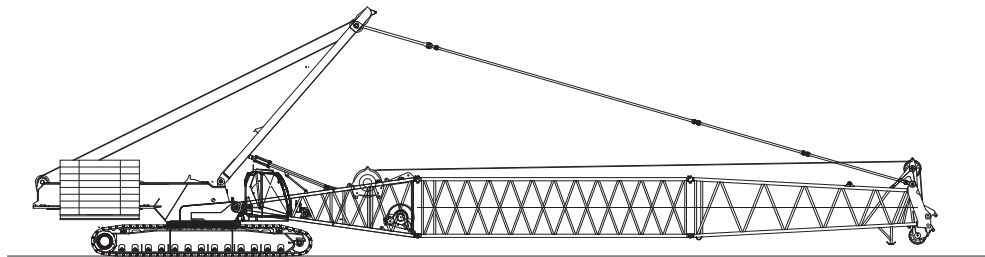
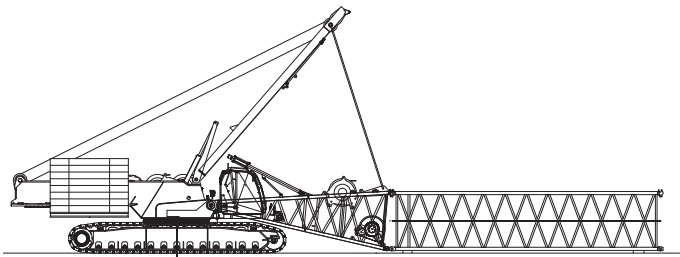
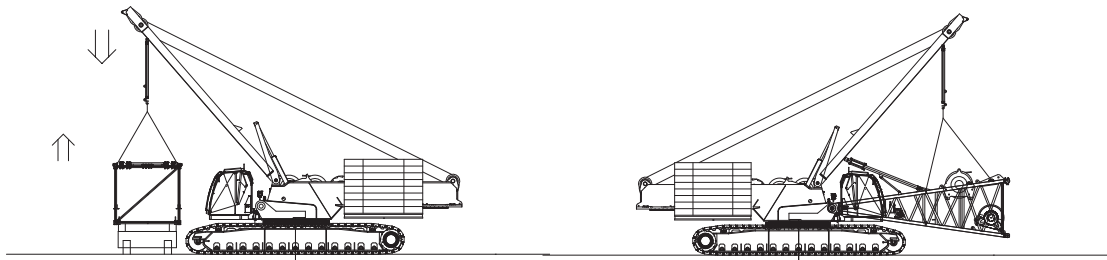

Performance data

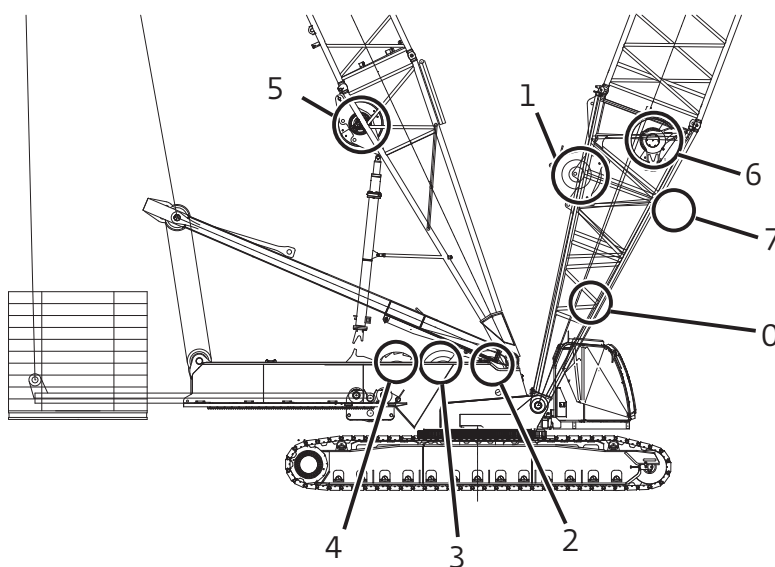

Drum identification	
Drum number	Function
1	Main hoist
2*	Auxiliary front hoist (optional)
3*	Auxiliary rear hoist (optional)
4	Boom/Mast Hoist (VPC-MAX™)
5	Boom hoist (VPC-MAX™)
6	Luffing/auxiliary hoist
7	Tagline winch
0	Rigging winch

**fre fall optional*

Working weight	
30 m B10:500 boom	305 261 kg
upper boom point	
22,2 t hook ball	
330 t hook block	
175,2 t counterweight	
2 swing drives	

Performance data

B10:500 / B60:500 boom Hoist reeving for main load block single lead line - 28 mm wire rope

No. parts of line	Maximum load
	kg
1	16,670
2	33,340
3	50,010
4	66,680
5	83,350
6	100,020
7	116,690
8	133,360
9	150,030
10	166,700
11	183,370
12	200,040
13	216,710
14	233,380
15	250,050
16	266,720
17	283,390
18	300,000

B10:500 / B60:500 boom Hoist reeving for drum #6 28 mm wire rope

No. parts of line	Maximum load
	kg
1	13 600
2	27 200

Performance for aux/luffing (drum #6) 28 mm wire rope 13 600 kg maximum line pull

Single line pull kg	Single line pull/single line speed m/min						
	Layer						
	1	2	3	4	5	6	7
0	73	79	85	91	96	102	108
2270	72	77	83	89	94	100	105
4535	71	76	81	87	92	97	102
6805	69	75	80	85	90	90	91
9070	67	68	69	69	70	71	71
11340	55	56	57	58	58	59	59
16670	48	48	49	50	50	51	52

Performance for main (drum #1) 28 mm wire rope 16 670 kg maximum line pull

Single line pull kg	Single line pull/single line speed m/min							
	Layer							
	1	2	3	4	5	6	7	8
0	105	113	122	130	138	147	155	163
2270	103	112	119	123	135	143	151	159
4536	102	109	117	125	132	140	148	155
6805	100	107	115	117	118	119	119	120
9070	89	89	90	91	91	92	92	93
11340	73	73	74	74	75	76	76	77
13610	52	52	53	54	54	55	55	56

For specific configurations refer to www.cranelibrary.com.

Boom combinations

B10:500 main boom combinations				
Boom length m	Main boom inserts m			
	6,0 M	12,0 H	12,0 M	12,0 L
30	0	1	0	0
36	1	1	0	0
42	0	1	1	0
48	1	1	1	0
54	0	1	2	0
60	1	1	2	0
66	0	1	3	0
72	1	1	3	0
78	0	1	3	1
84	1	1	3	1
90	0	1	3	2
96	1	1	3	2
102	0	1	3	3

No. 148 fixed Jib combinations		
Fixed jib m	Fixed Jib inserts m	
	6,0	12,0
12,0	0	0
18,0	1	0
24,0	0	1
30,0	1	1
36,0	0	2
42,0	1	2

LJ10:501 luffing jib combinations		
Luffing jib length m	Luffing jib inserts m	
	6,0	12,0
24	0	0
30	1	0
36	0	1
42	1	1
48	0	2
54	1	2
60	0	3
66	1	3
72	0	4
78	1	4
84	0	5
90	1	5
96	0	6

H - heavy inserts
M - medium inserts
L - light inserts

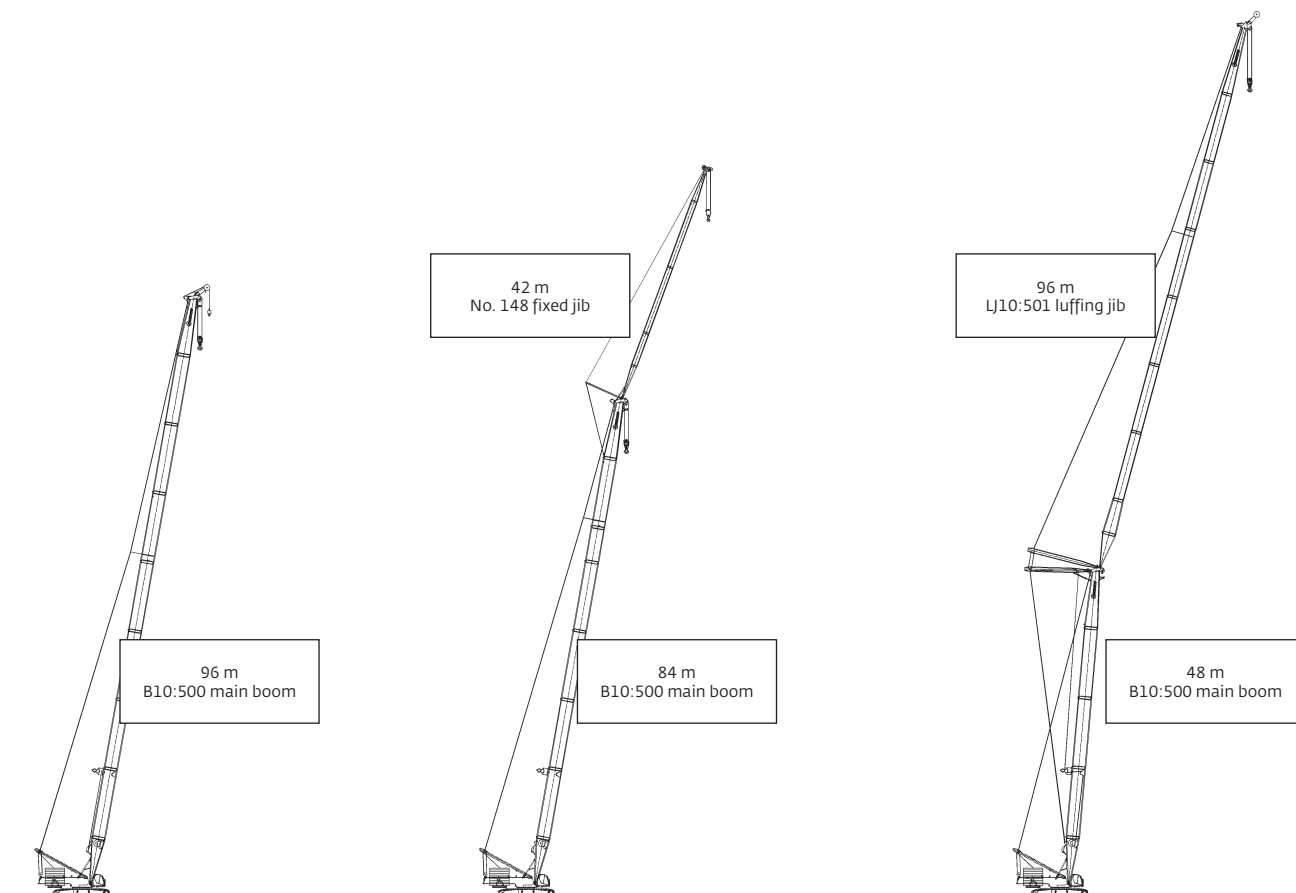

Main boom range diagram

B10:500 boom

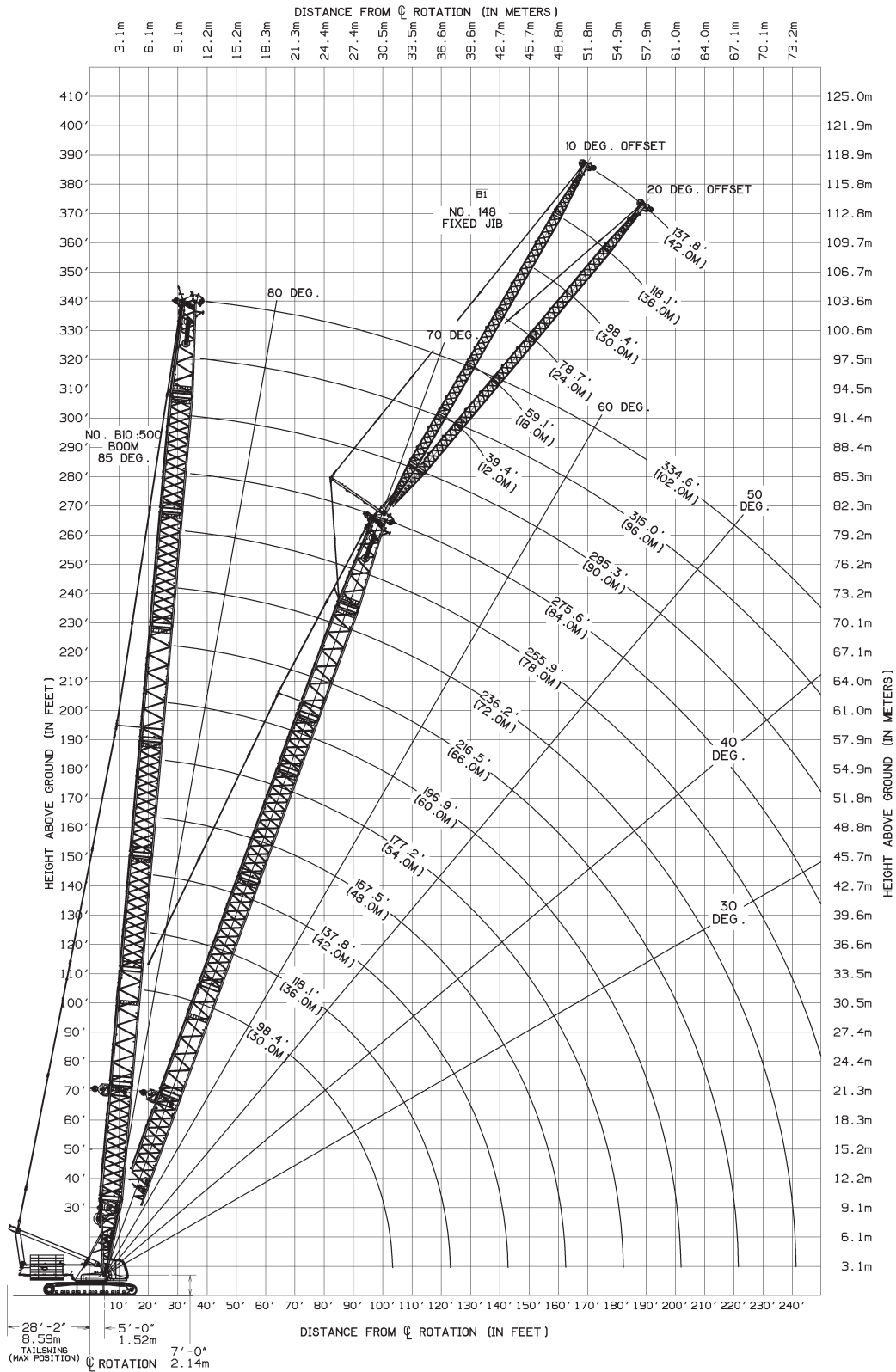

THIS CHART IS ONLY A GUIDE AND SHOULD NOT BE USED TO OPERATE THE CRANE.

The individual crane's load chart, operating instructions and other instructional plates must be read and understood prior to operating the crane

Main boom load charts

B10:500 boom Series 3

215,2 t counterweight

360° Rating

Radius m	kg x 1000													
	Boom length m													
	28	30	36	42	48	54	60	66	72	78	84	90	96	102
5,5	350,0*	300,0	—	—	—	—	—	—	—	—	—	—	—	—
6	—	300,0	293,7	—	—	—	—	—	—	—	—	—	—	—
6,5	—	299,0	291,0	267,4	—	—	—	—	—	—	—	—	—	—
7	—	290,0	282,6	264,9	—	—	—	—	—	—	—	—	—	—
8	—	258,8	253,3	246,3	239,5	220,5	192,1	—	—	—	—	—	—	—
9	—	235,2	230,8	225,2	219,3	213,2	187,7	166,9	—	—	—	—	—	—
10	—	214,5	212,0	207,3	202,5	197,4	179,2	160,4	139,3	116,1	—	—	—	—
11	—	190,7	192,6	191,9	187,9	183,8	171,3	154,0	137,2	115,3	97,5	82,4	71,0	—
12	—	167,8	169,4	170,4	172,0	171,3	163,7	147,8	132,0	114,6	96,8	81,9	70,5	59,6
14	—	135,0	136,4	137,0	137,9	139,1	140,8	135,7	122,2	113,1	95,5	80,6	69,4	58,7
16	—	112,8	114,0	114,5	115,2	116,3	117,2	118,8	113,2	111,5	94,2	76,6	68,4	57,7
18	—	96,7	97,8	98,2	98,8	99,8	100,7	101,2	102,1	103,1	92,1	72,4	67,5	56,8
20	—	84,5	85,6	85,9	86,4	87,4	88,1	88,6	89,3	89,8	87,2	68,6	66,5	54,4
22	—	75,0	75,9	76,2	76,7	77,5	78,2	78,7	79,3	79,8	80,9	65,2	65,5	51,7
24	—	67,3	68,2	68,4	68,8	69,7	70,3	70,7	71,3	71,7	72,3	62,1	63,8	49,2
26	—	61,0	61,8	62,0	62,4	63,2	63,8	64,2	64,7	65,1	65,6	59,3	61,8	46,8
28	—	55,6	56,5	56,7	57,0	57,8	58,3	58,7	59,1	59,5	60,0	56,6	59,2	44,7
30	—	51,1	51,9	52,1	52,4	53,1	53,6	54,0	54,4	54,8	55,0	54,2	53,6	42,8
34	—	—	44,6	44,8	45,0	45,7	46,2	46,5	46,9	47,1	45,6	45,7	44,1	39,2
38	—	—	—	39,2	39,3	40,0	40,5	40,7	40,6	39,8	38,2	38,3	36,7	36,2
42	—	—	—	—	34,8	35,5	35,9	35,9	34,5	33,8	32,3	32,3	30,8	30,5
46	—	—	—	—	31,2	31,9	31,3	30,8	29,5	28,9	27,4	27,4	25,9	25,7
50	—	—	—	—	—	27,6	26,9	26,6	25,4	24,7	23,3	23,3	21,9	21,6
54	—	—	—	—	—	—	23,1	22,9	21,8	21,2	19,8	19,8	18,4	18,1
58	—	—	—	—	—	—	19,5	19,6	18,6	18,1	16,8	16,8	15,4	15,1
62	—	—	—	—	—	—	—	16,7	15,8	15,4	14,1	14,1	12,8	12,5
66	—	—	—	—	—	—	—	—	13,3	13,0	11,8	11,8	10,5	10,2
70	—	—	—	—	—	—	—	—	10,9	10,8	9,6	9,7	8,4	8,2
74	—	—	—	—	—	—	—	—	—	8,7	7,7	7,8	6,5	6,3
78	—	—	—	—	—	—	—	—	—	—	5,9	6,1	—	—

*Note: Special equipment required.

B10:500 boom Series 2

175,2 t counterweight

360° Rating

Radius m	kg x 1000													
	Boom length m													
	30	36	42	48	54	60	66	72	78	84	90	96	102	
5,5	300,0	—	—	—	—	—	—	—	—	—	—	—	—	—
6	300,0	293,7	—	—	—	—	—	—	—	—	—	—	—	—
8	253,1	247,7	241,0	234,2	220,4	192,1	—	—	—	—	—	—	—	—
10	193,1	195,4	197,3	196,5	193,2	179,2	160,4	139,3	116,1	—	—	—	—	—
12	146,8	148,4	149,2	150,3	151,7	153,4	147,8	132,0	114,6	96,8	81,9	70,5	59,6	—
14	118,0	119,4	120,1	120,9	122,1	123,2	124,3	121,7	113,1	95,5	80,6	69,4	58,7	—
16	98,5	99,7	100,2	100,9	102,0	103,0	103,6	105,2	107,2	94,2	76,6	68,4	57,7	—
18	84,4	85,5	85,9	86,5	87,5	88,4	88,9	89,7	90,3	90,4	72,4	67,5	56,8	—
20	73,7	74,7	75,1	75,6	76,5	77,3	77,8	78,5	79,0	79,7	68,6	66,5	54,4	—
22	65,3	66,3	66,6	67,0	67,9	68,6	69,0	69,7	70,2	70,7	65,2	65,5	51,7	—
24	58,6	59,5	59,7	60,1	61,0	61,6	62,0	62,6	63,0	63,6	62,1	63,7	49,2	—
26	53,0	53,9	54,1	54,4	55,3	55,8	56,2	56,7	57,2	57,6	57,9	58,4	46,8	—
28	48,4	49,2	49,4	49,7	50,5	51,0	51,4	51,9	52,2	52,6	52,8	52,1	44,7	—
30	44,4	45,2	45,4	45,6	46,4	46,9	47,3	47,7	48,1	47,7	47,5	46,7	42,8	—
34	—	38,8	38,9	39,2	39,9	40,3	40,6	40,2	39,9	39,1	39,0	38,2	38,1	—
38	—	—	34,0	34,2	34,9	34,6	34,4	33,7	33,3	32,6	32,4	31,6	31,4	—
42	—	—	—	30,1	30,1	29,4	29,3	28,5	28,1	27,4	27,2	26,4	26,2	—
46	—	—	—	25,8	25,9	25,2	25,0	24,3	23,9	23,1	23,0	22,2	22,0	—
50	—	—	—	—	22,3	21,7	21,5	20,8	20,4	19,6	19,5	18,7	18,4	—
54	—	—	—	—	—	18,7	18,6	17,8	17,5	16,7	16,5	15,7	15,5	—
58	—	—	—	—	—	16,1	16,	15,3	14,9	14,1	14,0	13,2	13,0	—
62	—	—	—	—	—	—	13,8	13,1	12,7	11,9	11,8	11,0	10,8	—
66	—	—	—	—	—	—	—	11,1	10,8	10,0	9,9	9,1	8,9	—
70	—	—	—	—	—	—	—	—	9,4	9,1	8,3	8,2	7,4	7,2
74	—	—	—	—	—	—	—	—	—	7,6	6,8	6,7	5,9	5,7
78	—	—	—	—	—	—	—	—	—	—	5,4	5,4	—	—

For complete chart, refer to www.cranelibrary.com.

THIS CHART IS ONLY A GUIDE AND SHOULD NOT BE USED TO OPERATE THE CRANE.

The individual crane's load chart, operating instructions and other instructional plates must be read and understood prior to operating the crane

Fixed jib range diagram

No. 148 fixed jib on B10:500 boom

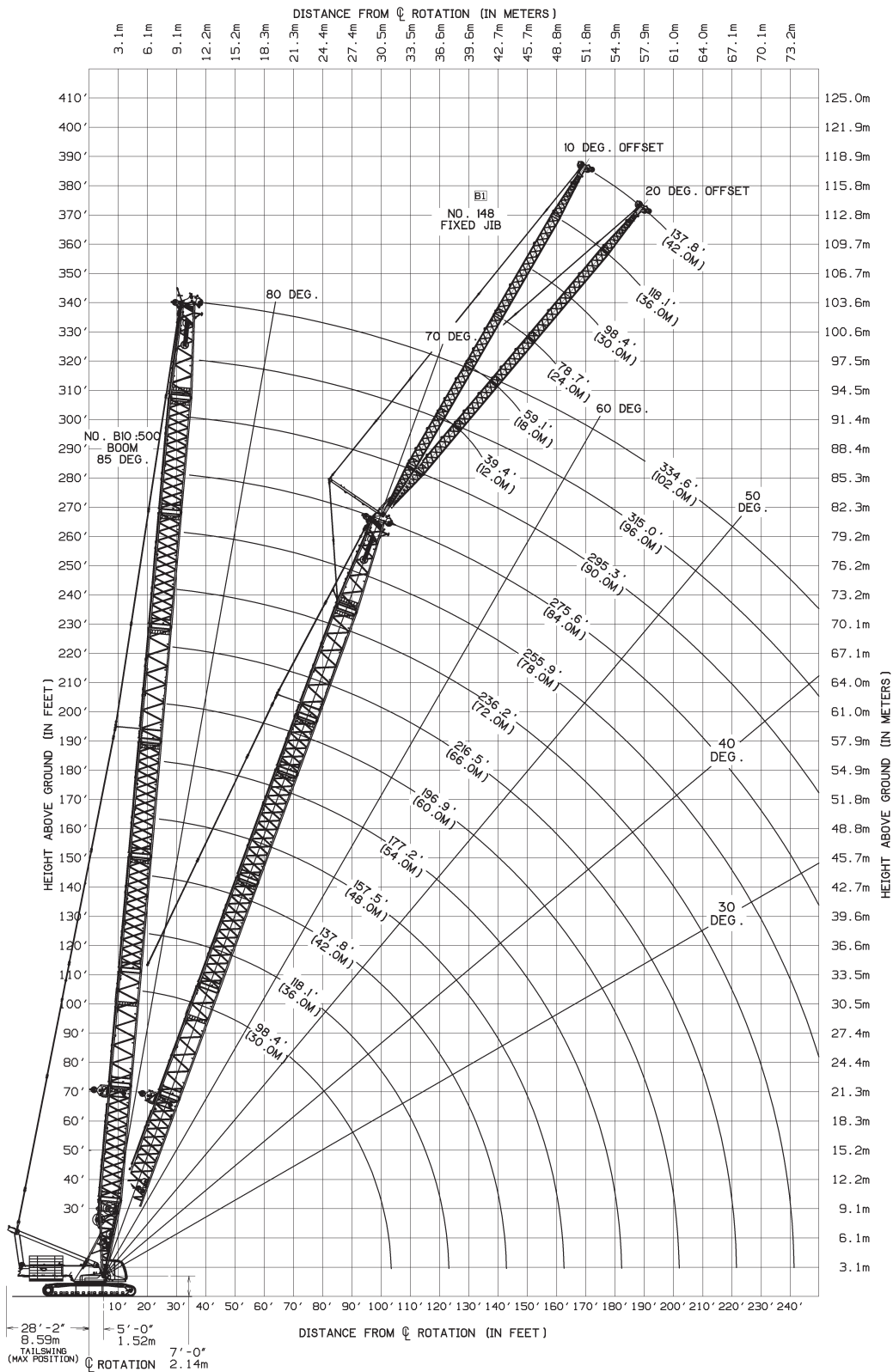

THIS CHART IS ONLY A GUIDE AND SHOULD NOT BE USED TO OPERATE THE CRANE.

The individual crane's load chart, operating instructions and other instructional plates must be read and understood prior to operating the crane

Fixed jib load charts

No. 148 fixed jib on B10:500 boom Series 3

215,2 t counterweight

360° Rating

kg x 1000

12 m jib length		10° offset				
Radius m	boom length m					
	30	42	60	78	90	
10,0	65,0	65,0	—	—	—	
12,0	65,0	65,0	65,0	—	—	
14,0	65,0	65,0	65,0	63,8	55,3	
16,0	65,0	65,0	65,0	63,4	52,1	
18,0	61,8	65,0	65,0	63,0	49,2	
20,0	56,8	64,7	65,0	61,7	46,5	
24,0	49,0	57,6	64,5	56,7	41,9	
28,0	43,2	51,2	56,9	52,5	38,0	
32,0	38,6	46,1	48,1	48,8	34,7	
36,0	35,1	40,6	41,6	42,4	31,9	
40,0	32,4	35,6	36,5	37,0	29,5	
44,0	—	31,5	32,3	31,5	27,3	
48,0	—	28,2	29,0	26,9	25,2	
52,0	—	25,4	25,8	23,1	21,5	
56,0	—	—	22,4	19,8	18,2	
60,0	—	—	19,4	16,9	15,4	
64,0	—	—	16,6	14,4	12,9	
68,0	—	—	14,1	12,1	10,7	
72,0	—	—	—	10,1	8,7	
80,0	—	—	—	6,5	5,3	
88,0	—	—	—	3,3	—	

12 m jib length		20° offset				
Radius m	boom length m					
	30	42	60	78	90	
12,0	62,0	65,0	—	—	—	
14,0	56,9	61,0	63,6	—	—	
16,0	52,6	57,1	61,6	58,0	46,6	
18,0	48,9	53,7	58,6	55,7	44,3	
20,0	45,7	50,7	55,9	53,7	42,1	
24,0	40,6	45,7	51,2	49,9	38,3	
28,0	36,6	41,6	47,4	46,7	35,0	
32,0	33,6	38,4	44,0	43,9	32,2	
36,0	31,2	35,7	41,3	41,5	29,8	
40,0	—	33,4	36,6	37,3	27,7	
44,0	—	31,5	32,4	32,1	25,8	
48,0	—	28,2	29,0	27,5	24,2	
52,0	—	—	26,2	23,6	22,1	
56,0	—	—	22,7	20,2	18,8	
60,0	—	—	19,6	17,3	15,8	
64,0	—	—	16,8	14,7	13,3	
68,0	—	—	—	12,4	11,0	
72,0	—	—	—	10,3	9,0	
80,0	—	—	—	6,7	5,5	

24 m jib length		10° offset				
Radius m	boom length m					
	30	42	60	78	90	
14,0	37,6	38,2	—	—	—	
16,0	36,1	37,0	37,2	—	—	
18,0	34,7	35,8	36,3	35,5	—	
20,0	33,3	34,6	35,4	34,9	32,4	
24,0	30,8	32,6	33,8	33,7	31,3	
28,0	27,0	30,6	32,3	32,6	28,7	
32,0	23,9	27,5	31,0	31,5	26,3	
36,0	21,5	24,9	29,2	30,5	24,2	
40,0	19,5	22,7	26,8	29,3	22,3	
44,0	17,8	20,9	24,9	27,6	20,7	
48,0	16,4	19,3	23,2	26,1	19,3	
52,0	15,3	18,0	21,7	24,7	18,0	
56,0	—	16,8	20,3	21,7	16,8	
60,0	—	15,8	19,2	18,8	15,8	
64,0	—	15,0	18,2	16,2	14,7	
68,0	—	—	16,6	14,0	12,4	
72,0	—	—	14,4	12,0	10,4	
80,0	—	—	10,6	8,5	7,0	
88,0	—	—	—	5,5	4,2	

24 m jib length		20° offset				
Radius m	boom length m					
	30	42	60	78	90	
18,0	29,1	30,5	—	—	—	
20,0	27,1	28,7	30,3	31,0	—	
24,0	23,8	25,7	27,6	28,8	27,6	
28,0	21,2	23,2	25,4	26,8	25,5	
32,0	19,1	21,2	23,5	25,1	23,5	
36,0	17,4	19,5	21,9	23,6	21,9	
40,0	16,0	18,0	20,4	22,2	20,4	
44,0	14,9	16,8	19,2	21,0	19,0	
48,0	13,9	15,8	18,1	20,0	17,8	
52,0	—	14,9	17,2	19,0	16,7	
56,0	—	14,1	16,3	18,2	15,7	
60,0	—	13,5	15,6	17,4	14,8	
64,0	—	—	14,9	16,7	14,0	
68,0	—	—	14,3	14,7	13,1	
72,0	—	—	13,8	12,6	11,1	
80,0	—	—	—	8,9	7,6	
88,0	—	—	—	5,9	4,6	

For complete chart, refer to www.cranelibrary.com.

THIS CHART IS ONLY A GUIDE AND SHOULD NOT BE USED TO OPERATE THE CRANE.

The individual crane's load chart, operating instructions and other instructional plates must be read and understood prior to operating the crane

Fixed jib load charts

No. 148 fixed jib on B10:500 boom Series 3

215,2 t counterweight

360° Rating

kg x 1000

30 m jib length		10° offset				
Radius m	boom length m					
	30	42	60	78	84	
14,0	30,2	30,5	—	—	—	
16,0	29,1	29,5	29,5	—	—	
18,0	27,9	28,6	28,8	—	—	
20,0	26,8	27,7	28,2	27,7	27,4	
24,0	24,5	25,9	26,9	26,7	26,5	
28,0	22,5	24,1	25,6	25,8	25,7	
32,0	20,7	22,5	24,2	24,8	24,8	
36,0	18,8	21,0	22,9	23,9	24,0	
40,0	16,9	19,6	21,8	22,9	23,1	
44,0	15,3	17,9	20,7	22,0	22,2	
48,0	14,0	16,5	19,7	21,1	21,4	
52,0	12,9	15,2	18,3	20,3	20,7	
56,0	11,9	14,1	17,1	19,5	19,9	
60,0	—	13,2	16,1	18,5	18,0	
64,0	—	12,4	15,1	16,8	15,5	
68,0	—	11,6	14,2	14,6	13,2	
72,0	—	—	13,5	12,5	11,3	
76,0	—	—	12,8	10,7	9,5	
80,0	—	—	11,5	9,1	7,8	
88,0	—	—	8,2	6,2	5,0	

30 m jib length		20° offset				
Radius m	boom length m					
	30	42	60	78	84	
20,0	23,9	24,5	—	—	—	
24,0	21,1	22,5	23,6	23,6	23,5	
28,0	18,6	20,1	21,9	22,7	22,7	
32,0	16,6	18,2	20,1	21,3	21,8	
36,0	15,0	16,6	18,6	20,0	20,4	
40,0	13,6	15,3	17,3	18,7	19,2	
44,0	12,5	14,2	16,1	17,6	18,1	
48,0	11,6	13,2	15,1	16,6	17,1	
52,0	10,8	12,3	14,2	15,7	16,2	
56,0	10,1	11,6	13,4	14,9	15,4	
60,0	—	10,9	12,7	14,2	14,7	
64,0	—	10,4	12,1	13,6	14,1	
68,0	—	9,9	11,5	13,0	13,5	
72,0	—	—	11,0	12,5	12,1	
76,0	—	—	10,6	11,5	10,3	
80,0	—	—	10,2	9,7	8,6	
88,0	—	—	—	6,7	5,6	
96,0	—	—	—	4,1	3,0	

42 m jib length		10° offset				
Radius m	boom length m					
	30	42	60	78	84	
16,0	19,7	—	—	—	—	
18,0	18,7	19,2	—	—	—	
20,0	17,8	18,4	18,8	17,9	17,6	
24,0	16,1	16,9	17,6	17,3	17,1	
28,0	14,5	15,5	16,5	16,7	16,5	
32,0	13,1	14,2	15,4	15,9	16,0	
36,0	11,8	13,1	14,3	15,1	15,2	
40,0	10,7	12,0	13,4	14,2	14,4	
44,0	9,7	11,0	12,5	13,4	13,7	
48,0	8,9	10,1	11,7	12,7	13,0	
52,0	8,1	9,3	10,9	12,0	12,3	
56,0	7,4	8,6	10,2	11,4	11,7	
60,0	6,8	8,0	9,5	10,8	11,1	
64,0	6,2	7,4	9,0	10,2	10,5	
68,0	5,8	6,9	8,4	9,7	10,0	
72,0	—	6,4	7,9	9,2	9,5	
76,0	—	6,0	7,5	8,7	9,1	
80,0	—	5,7	7,0	8,2	8,6	
88,0	—	—	6,3	7,3	6,1	
96,0	—	—	5,7	5,0	3,8	

42 m jib length		20° offset				
Radius m	boom length m					
	30	42	60	78	84	
24,0	14,2	14,6	—	—	—	
28,0	12,9	13,4	14,0	14,1	14,2	
32,0	11,7	12,4	13,1	13,4	13,5	
36,0	10,6	11,4	12,2	12,7	12,8	
40,0	9,7	10,5	11,5	12,0	12,2	
44,0	8,9	9,7	10,7	11,4	11,6	
48,0	8,1	9,0	10,1	10,9	11,0	
52,0	7,5	8,4	9,5	10,3	10,5	
56,0	6,9	7,8	9,0	9,8	10,0	
60,0	6,4	7,3	8,4	9,3	9,6	
64,0	5,9	6,8	8,0	8,9	9,1	
68,0	5,6	6,4	7,5	8,4	8,7	
72,0	—	6,1	7,1	8,1	8,3	
76,0	—	5,7	6,8	7,7	8,0	
80,0	—	5,5	6,4	7,3	7,7	
88,0	—	—	5,9	6,7	7,0	
96,0	—	—	5,5	5,6	4,5	
104,0	—	—	—	3,4	—	

For complete chart, refer to www.cranelibrary.com.

THIS CHART IS ONLY A GUIDE AND SHOULD NOT BE USED TO OPERATE THE CRANE.

The individual crane's load chart, operating instructions and other instructional plates must be read and understood prior to operating the crane

Fixed jib load charts

No. 148 fixed jib on B10:500 boom Series 2

175,2 t counterweight

360° Rating

kg x 1000

12 m jib length		10° offset				
Radius m	boom length m					
	30	42	60	78	90	
10,0	65,0	65,0	—	—	—	
12,0	65,0	65,0	65,0	—	—	
14,0	65,0	65,0	65,0	63,8	55,3	
16,0	65,0	65,0	65,0	63,4	52,1	
18,0	61,8	65,0	65,0	63,0	49,2	
20,0	56,8	64,7	65,0	61,7	46,5	
24,0	49,0	57,6	60,3	56,7	41,9	
28,0	43,2	48,4	49,6	50,7	38,0	
32,0	38,6	40,8	41,9	42,8	34,7	
36,0	34,6	35,1	36,1	36,9	31,9	
40,0	30,2	30,7	31,6	31,2	29,4	
44,0	—	27,1	27,9	26,5	25,4	
48,0	—	24,2	24,1	22,5	21,5	
52,0	—	21,7	20,9	19,3	18,2	
56,0	—	—	18,1	16,5	15,4	
60,0	—	—	15,7	14,1	13,0	
64,0	—	—	13,6	12,0	10,9	
68,0	—	—	11,7	10,2	9,1	
72,0	—	—	—	8,5	7,5	
76,0	—	—	—	7,1	6,0	
80,0	—	—	—	5,8	4,4	

12 m jib length		20° offset				
Radius m	boom length m					
	30	42	60	78	90	
12,0	62,0	65,0	—	—	—	
14,0	56,9	61,0	63,6	—	—	
16,0	52,6	57,1	61,6	58,0	46,6	
18,0	48,9	53,7	58,6	55,7	44,3	
20,0	45,7	50,7	55,9	53,7	42,1	
24,0	40,6	45,7	51,2	49,9	38,3	
28,0	36,6	41,6	47,4	46,7	35,0	
32,0	33,6	38,4	42,1	43,0	32,2	
36,0	31,2	35,2	36,3	37,1	29,8	
40,0	—	30,8	31,7	31,9	27,7	
44,0	—	27,2	28,0	27,0	25,8	
48,0	—	24,2	24,5	23,0	22,0	
52,0	—	—	21,2	19,7	18,7	
56,0	—	—	18,3	16,9	15,8	
60,0	—	—	15,9	14,4	13,4	
64,0	—	—	13,7	12,3	11,3	
68,0	—	—	—	10,4	9,4	
72,0	—	—	—	8,7	7,7	
76,0	—	—	—	7,2	6,2	
80,0	—	—	—	5,9	4,6	

24 m jib length		10° offset				
Radius m	boom length m					
	30	42	60	78	90	
14,0	37,6	38,2	—	—	—	
16,0	36,1	37,0	37,2	—	—	
18,0	34,7	35,8	36,3	35,5	—	
20,0	33,3	34,6	35,4	34,9	32,4	
24,0	30,8	32,6	33,8	33,7	31,3	
28,0	27,0	30,6	32,3	32,6	28,7	
32,0	23,9	27,5	31,0	31,5	26,3	
36,0	21,5	24,9	29,2	30,5	24,2	
40,0	19,5	22,7	26,8	29,3	22,3	
44,0	17,8	20,9	24,9	27,6	20,7	
48,0	16,4	19,3	23,2	24,3	19,3	
52,0	15,3	18,0	21,7	21,0	18,0	
56,0	—	16,8	19,8	18,1	16,8	
60,0	—	15,8	17,4	15,7	14,6	
64,0	—	15,0	15,2	13,6	12,5	
68,0	—	—	13,4	11,7	10,6	
72,0	—	—	11,7	10,0	8,9	
76,0	—	—	10,2	8,6	7,5	
80,0	—	—	8,8	7,2	6,1	

24 m jib length		20° offset				
Radius m	boom length m					
	30	42	60	78	90	
18,0	29,1	30,5	—	—	—	
20,0	27,1	28,7	30,3	31,0	—	
24,0	23,8	25,7	27,6	28,8	27,6	
28,0	21,2	23,2	25,4	26,8	25,5	
32,0	19,1	21,2	23,5	25,1	23,5	
36,0	17,4	19,5	21,9	23,6	21,9	
40,0	16,0	18,0	20,4	22,2	20,4	
44,0	14,9	16,8	19,2	21,0	19,0	
48,0	13,9	15,8	18,1	20,0	17,8	
52,0	—	14,9	17,2	19,0	16,7	
56,0	—	14,1	16,3	18,2	15,7	
60,0	—	13,5	15,6	16,4	14,8	
64,0	—	—	14,9	14,2	13,2	
68,0	—	—	13,7	12,2	11,2	
72,0	—	—	12,0	10,5	9,5	
76,0	—	—	10,4	9,0	8,0	
80,0	—	—	—	7,6	6,6	
88,0	—	—	—	5,1	3,8	

For complete chart, refer to www.cranelibrary.com.

THIS CHART IS ONLY A GUIDE AND SHOULD NOT BE USED TO OPERATE THE CRANE.

The individual crane's load chart, operating instructions and other instructional plates must be read and understood prior to operating the crane

Fixed jib load charts

No. 148 fixed jib on B10:500 boom Series 2

175,2 t counterweight

360° Rating

kg x 1000

30 m jib length		10° offset				
Radius m	boom length m					
	30	42	60	78	84	
14,0	30,2	30,5	—	—	—	
16,0	29,1	29,5	29,5	—	—	
18,0	27,9	28,6	28,8	—	—	
20,0	26,8	27,7	28,2	27,7	27,4	
24,0	24,5	25,9	26,9	26,7	26,5	
28,0	22,5	24,1	25,6	25,8	25,7	
32,0	20,7	22,5	24,2	24,8	24,8	
36,0	18,8	21,0	22,9	23,9	24,0	
40,0	16,9	19,6	21,8	22,9	23,1	
44,0	15,3	17,9	20,7	22,0	22,2	
48,0	14,0	16,5	19,7	21,1	21,4	
52,0	12,9	15,2	18,3	20,3	20,6	
56,0	11,9	14,1	17,1	18,6	17,9	
60,0	—	13,2	16,1	16,2	15,4	
64,0	—	12,4	15,1	14,0	13,3	
68,0	—	11,6	13,9	12,2	11,4	
72,0	—	—	12,3	10,5	9,7	
76,0	—	—	10,8	9,1	8,3	
80,0	—	—	9,4	7,7	6,9	
88,0	—	—	7,0	5,4	4,4	

30 m jib length		20° offset				
Radius m	boom length m					
	30	42	60	78	84	
20,0	23,9	24,5	—	—	—	
24,0	21,1	22,5	23,6	23,6	23,5	
28,0	18,6	20,1	21,9	22,7	22,7	
32,0	16,6	18,2	20,1	21,3	21,8	
36,0	15,0	16,6	18,6	20,0	20,4	
40,0	13,6	15,3	17,3	18,7	19,2	
44,0	12,5	14,2	16,1	17,6	18,1	
48,0	11,6	13,2	15,1	16,6	17,1	
52,0	10,8	12,3	14,2	15,7	16,2	
56,0	10,1	11,6	13,4	14,9	15,4	
60,0	—	10,9	12,7	14,2	14,7	
64,0	—	10,4	12,1	13,6	14,1	
68,0	—	9,9	11,5	12,8	12,2	
72,0	—	—	11,0	11,2	10,4	
76,0	—	—	10,6	9,6	8,9	
80,0	—	—	9,7	8,2	7,5	
88,0	—	—	—	5,8	5,0	

42 m jib length		10° offset				
Radius m	boom length m					
	30	42	60	78	84	
16,0	19,7	—	—	—	—	
18,0	18,7	19,2	—	—	—	
20,0	17,8	18,4	18,8	17,9	17,6	
24,0	16,1	16,9	17,6	17,3	17,1	
28,0	14,5	15,5	16,5	16,7	16,5	
32,0	13,1	14,2	15,4	15,9	16,0	
36,0	11,8	13,1	14,3	15,1	15,2	
40,0	10,7	12,0	13,4	14,2	14,4	
44,0	9,7	11,0	12,5	13,4	13,7	
48,0	8,9	10,1	11,7	12,7	13,0	
52,0	8,1	9,3	10,9	12,0	12,3	
56,0	7,4	8,6	10,2	11,4	11,7	
60,0	6,8	8,0	9,5	10,8	11,1	
64,0	6,2	7,4	9,0	10,2	10,5	
68,0	5,8	6,9	8,4	9,7	10,0	
72,0	—	6,4	7,9	9,2	9,5	
76,0	—	6,0	7,5	8,7	9,1	
80,0	—	5,7	7,0	8,2	7,8	
88,0	—	—	6,3	6,3	5,5	
96,0	—	—	5,7	4,3	3,2	

42 m jib length		20° offset				
Radius m	boom length m					
	30	42	60	78	84	
24,0	14,2	14,6	—	—	—	
28,0	12,9	13,4	14,0	14,1	14,2	
32,0	11,7	12,4	13,1	13,4	13,5	
36,0	10,6	11,4	12,2	12,7	12,8	
40,0	9,7	10,5	11,5	12,0	12,2	
44,0	8,9	9,7	10,7	11,4	11,6	
48,0	8,1	9,0	10,1	10,9	11,0	
52,0	7,5	8,4	9,5	10,3	10,5	
56,0	6,9	7,8	9,0	9,8	10,0	
60,0	6,4	7,3	8,4	9,3	9,6	
64,0	5,9	6,8	8,0	8,9	9,1	
68,0	5,6	6,4	7,5	8,4	8,7	
72,0	—	6,1	7,1	8,1	8,3	
76,0	—	5,7	6,8	7,7	8,0	
80,0	—	5,5	6,4	7,3	7,7	
88,0	—	—	5,9	6,7	6,2	
96,0	—	—	5,5	4,9	3,9	

For complete chart, refer to www.cranelibrary.com.

THIS CHART IS ONLY A GUIDE AND SHOULD NOT BE USED TO OPERATE THE CRANE.

The individual crane's load chart, operating instructions and other instructional plates must be read and understood prior to operating the crane

Luffing jib range diagram

LJ10:501 luffing jib on B10:500 boom

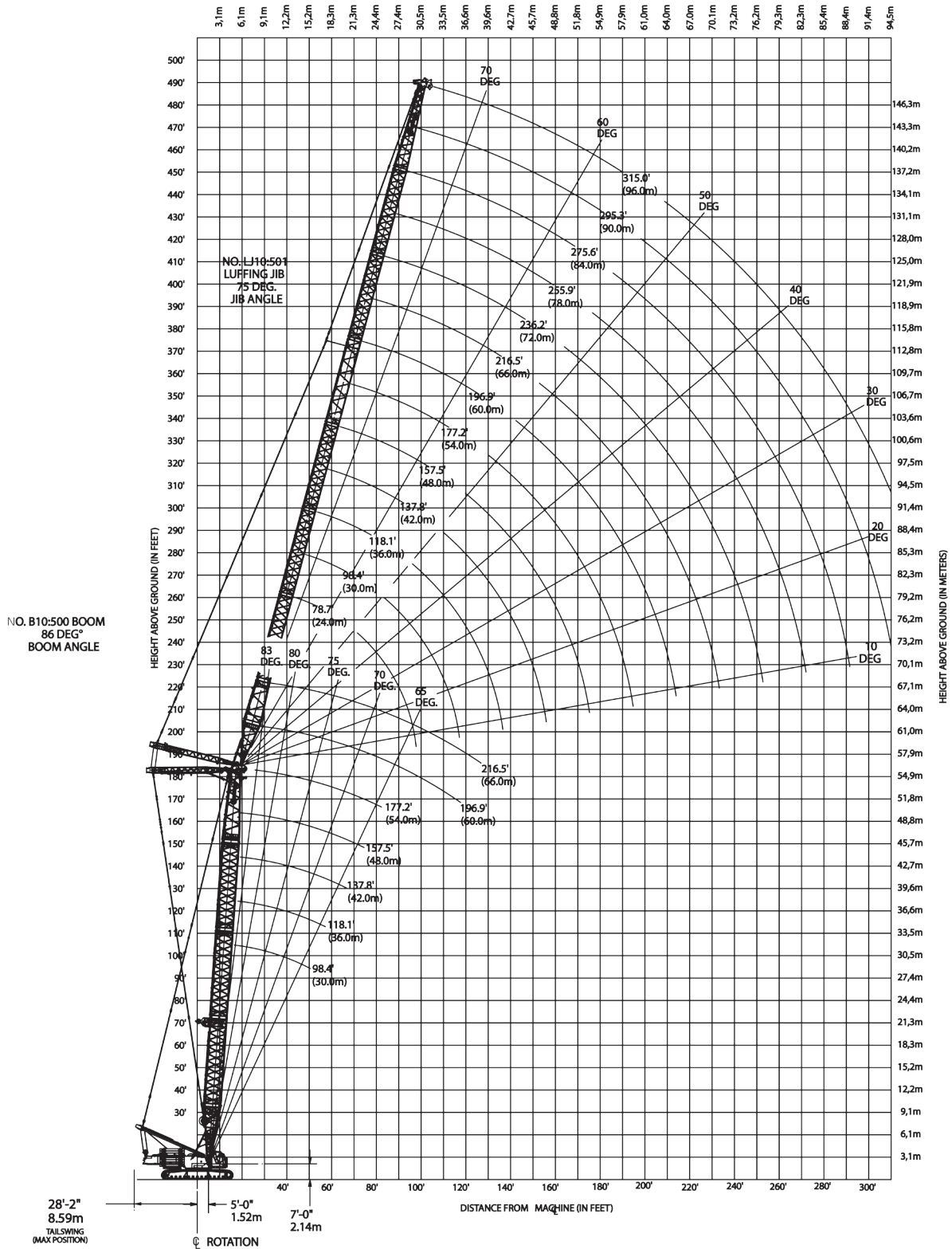

THIS CHART IS ONLY A GUIDE AND SHOULD NOT BE USED TO OPERATE THE CRANE.

The individual crane's load chart, operating instructions and other instructional plates must be read and understood prior to operating the crane

Luffing jib load charts

LJ10:501 luffing jib on B10:500 boom Series 3

215,2 t counterweight

360° Rating

kg x 1000

86° boom angle

30 m boom length					
Radius m	Luffing jib length m				
	24	42	60	78	90
11,6	150,0	—	—	—	—
12	144,1	—	—	—	—
14	126,4	—	—	—	—
16	112,9	—	—	—	—
18	101,8	89,0	—	—	—
20	92,5	83,3	—	—	—
22	84,3	77,5	59,8	—	—
24	76,0	71,7	58,3	—	—
26	69,2	66,6	57,0	34,2	—
28	—	62,2	55,3	33,6	—
30	—	58,2	52,8	33,0	22,9
34	—	51,3	46,9	31,9	22,0
38	—	45,2	42,0	30,9	21,1
42	—	39,4	37,8	29,9	20,2
46	—	—	34,3	29,0	19,5
50	—	—	31,2	28,0	18,8
54	—	—	28,5	25,6	18,2
58	—	—	25,2	23,4	17,6
62	—	—	19,9	20,8	17,1
66	—	—	—	18,2	16,6
70	—	—	—	15,8	16,2
74	—	—	—	13,5	15,3
78	—	—	—	11,3	14,0
82	—	—	—	—	12,9
86	—	—	—	—	10,9
90	—	—	—	—	7,9

42 m boom length					
Radius m	Luffing jib length m				
	24	42	60	78	90
12,2	141,5	—	—	—	—
14	130,6	—	—	—	—
16	118,4	—	—	—	—
18	105,6	—	—	—	—
20	93,8	82,5	—	—	—
22	84,7	77,8	—	—	—
24	77,0	73,3	53,8	—	—
26	70,1	68,5	53,4	—	—
28	63,6	64,0	52,9	31,0	—
30	—	59,8	51,7	30,6	—
34	—	52,1	48,1	29,8	20,9
38	—	46,0	44,8	29,0	20,1
42	—	41,1	41,5	28,3	19,5
46	—	—	37,6	27,5	18,8
50	—	—	33,6	26,9	18,2
54	—	—	29,5	25,7	17,6
58	—	—	25,5	23,3	17,1
62	—	—	21,6	20,9	16,6
66	—	—	—	18,5	16,2
70	—	—	—	16,1	15,8
74	—	—	—	13,9	15,5
78	—	—	—	11,8	14,2
82	—	—	—	9,9	12,4
86	—	—	—	—	10,6
90	—	—	—	—	8,8
94	—	—	—	—	6,6

48 m boom length					
Radius m	Luffing jib length m				
	24	42	60	78	90
13,7	126,4	—	—	—	—
14	124,9	—	—	—	—
16	114,5	—	—	—	—
18	104,9	—	—	—	—
20	93,8	81,2	—	—	—
22	84,6	76,9	—	—	—
24	77,3	72,8	49,8	—	—
26	70,6	68,7	49,5	—	—
28	64,1	64,3	49,1	29,5	—
30	—	60,1	48,6	29,2	—
34	—	52,4	47,2	28,5	20,1
38	—	46,3	44,1	27,8	19,5
42	—	40,6	40,8	27,1	18,9
46	—	33,2	36,6	26,5	18,3
50	—	—	32,5	25,9	17,7
54	—	—	28,5	25,2	17,2
58	—	—	24,7	23,1	16,8
62	—	—	21,0	20,8	16,3
66	—	—	—	18,5	15,9
70	—	—	—	16,3	15,6
74	—	—	—	14,1	15,1
78	—	—	—	12,0	13,4
82	—	—	—	10,1	11,7
86	—	—	—	—	10,0
90	—	—	—	—	8,2
94	—	—	—	—	6,3

60 m boom length					
Radius m	Luffing jib length m				
	24	36	48	54	60
13,7	104,9	—	—	—	—
14	103,8	—	—	—	—
16	95,9	—	—	—	—
18	88,4	76,1	—	—	—
20	81,6	74,2	56,8	—	—
22	75,4	69,5	56,2	48,7	—
24	69,8	65,2	55,3	48,2	41,5
26	64,6	61,2	54,3	47,5	41,1
28	59,6	57,5	52,6	46,8	40,7
30	—	54,1	49,8	46,1	40,2
34	—	47,8	44,8	43,0	39,2
38	—	42,3	40,4	39,0	37,4
42	—	—	36,3	35,3	34,1
46	—	—	32,7	32,0	31,0
50	—	—	29,3	29,0	28,3
54	—	—	—	26,1	25,7
58	—	—	—	22,5	23,3
62	—	—	—	—	20,6

For complete chart, refer to www.cranelibrary.com.

THIS CHART IS ONLY A GUIDE AND SHOULD NOT BE USED TO OPERATE THE CRANE.

The individual crane's load chart, operating instructions and other instructional plates must be read and understood prior to operating the crane

Luffing jib load charts

LJ10:501 luffing jib on B10:500 boom Series 2

175,2 t counterweight

360° Rating

kg x 1000

86° boom angle

30 m boom length					
Radius m	Luffing jib length m				
	24	42	60	78	90
11,6	150,0	—	—	—	—
12	144,1	—	—	—	—
14	126,4	—	—	—	—
16	111,3	—	—	—	—
18	95,3	89,0	—	—	—
20	83,7	83,2	—	—	—
22	74,6	75,7	59,8	—	—
24	67,3	68,1	58,3	—	—
26	61,3	62,0	57,0	34,2	—
28	—	56,9	55,3	33,6	—
30	—	52,6	52,8	33,0	22,9
34	—	45,6	46,1	31,9	22,0
38	—	40,3	40,7	30,9	21,1
42	—	36,0	36,4	29,9	20,2
46	—	—	32,8	29,0	19,5
50	—	—	29,2	27,9	18,8
54	—	—	26,2	25,0	18,2
58	—	—	23,6	22,4	17,6
62	—	—	20,0	20,2	17,1
66	—	—	—	18,2	16,6
70	—	—	—	15,8	15,8
74	—	—	—	13,5	14,3
78	—	—	—	11,3	13,0
82	—	—	—	—	11,7
86	—	—	—	—	10,6
90	—	—	—	—	7,9

42 m boom length					
Radius m	Luffing jib length m				
	24	42	60	78	90
12,2	141,5	—	—	—	—
14	130,2	—	—	—	—
16	112,8	—	—	—	—
18	96,7	—	—	—	—
20	85,0	82,5	—	—	—
22	75,7	76,9	—	—	—
24	68,3	69,0	53,8	—	—
26	62,2	62,9	53,4	—	—
28	57,1	57,7	52,9	31,0	—
30	—	53,3	51,7	30,6	—
34	—	46,3	46,8	29,8	20,9
38	—	40,9	41,3	29,0	20,1
42	—	36,6	36,8	28,3	19,5
46	—	—	32,5	27,5	18,8
50	—	—	29,0	26,9	18,2
54	—	—	26,0	24,7	17,6
58	—	—	23,4	22,2	17,1
62	—	—	21,2	20,0	16,6
66	—	—	—	18,1	16,2
70	—	—	—	16,1	15,6
74	—	—	—	13,9	14,1
78	—	—	—	11,8	12,8
82	—	—	—	9,9	11,6
86	—	—	—	—	10,5
90	—	—	—	—	8,8
94	—	—	—	—	6,6

48 m boom length					
Radius m	Luffing jib length m				
	24	42	60	78	90
13,7	126,4	—	—	—	—
14	124,9	—	—	—	—
16	112,9	—	—	—	—
18	97,6	—	—	—	—
20	85,6	81,2	—	—	—
22	76,3	76,5	—	—	—
24	68,8	69,7	49,8	—	—
26	62,7	63,3	49,5	—	—
28	57,5	58,1	49,1	29,5	—
30	—	53,7	48,6	29,2	—
34	—	46,6	47,1	28,5	20,1
38	—	41,2	41,6	27,8	19,5
42	—	36,9	36,5	27,1	18,9
46	—	33,1	32,3	26,5	18,3
50	—	—	28,8	25,9	17,7
54	—	—	25,8	24,6	17,2
58	—	—	23,3	22,1	16,8
62	—	—	20,9	19,9	16,3
66	—	—	—	18,0	15,9
70	—	—	—	16,3	15,5
74	—	—	—	14,1	14,0
78	—	—	—	12,0	12,7
82	—	—	—	10,1	11,5
86	—	—	—	—	10,0
90	—	—	—	—	8,2
94	—	—	—	—	6,3

60 m boom length					
Radius m	Luffing jib length m				
	24	36	48	54	60
13,7	104,9	—	—	—	—
14	103,8	—	—	—	—
16	95,9	—	—	—	—
18	88,4	76,1	—	—	—
20	81,6	74,2	56,8	—	—
22	75,4	69,5	56,2	48,7	—
24	69,5	65,2	55,3	48,2	41,5
26	63,4	61,2	54,3	47,5	41,1
28	58,2	57,5	52,6	46,8	40,7
30	—	54,0	49,8	46,1	40,2
34	—	47,0	44,8	43,0	39,2
38	—	41,5	40,4	39,0	37,4
42	—	—	36,3	35,3	34,1
46	—	—	32,6	32,0	31,0
50	—	—	29,1	28,7	28,3
54	—	—	—	25,8	25,5
58	—	—	—	22,5	23,0
62	—	—	—	—	20,6

For complete chart, refer to www.cranelibrary.com.

THIS CHART IS ONLY A GUIDE AND SHOULD NOT BE USED TO OPERATE THE CRANE.

The individual crane's load chart, operating instructions and other instructional plates must be read and understood prior to operating the crane

Boom combinations

VPC-MAX™

B60:500 VPC-MAX™ main boom combinations				
Boom length m	Main boom inserts m			
	6,0 M	12,0 H	12,0 M	12,0 L
42	0	1	1	0
48	1	1	1	0
54	0	1	2	0
60	1	1	2	0
66	0	1	3	0
72	1	1	3	0
78	0	1	3	1
84	1	1	3	1
90	0	1	3	2
96	1	1	3	2
102	0	1	3	3
108	1	1	3	3
114	0	1	4	3
120	1	1	4	3

No. 148 fixed jib combinations		
Fixed jib m	Fixed Jib inserts m	
	6,0	12,0
12,0	0	0
18,0	1	0
24,0	0	1
30,0	1	1
36,0	0	2
42,0	1	2

LJ10:501 VPC-MAX™ luffing jib combinations		
Luffing jib length m	Luffing jib inserts m	
	6,0	12,0
24	0	0
30	1	0
36	0	1
42	1	1
48	0	2
54	1	2
60	0	3
66	1	3
72	0	4
78	1	4
84	0	5
90	1	5
96	0	6

H - heavy inserts
M - medium inserts
L - light inserts

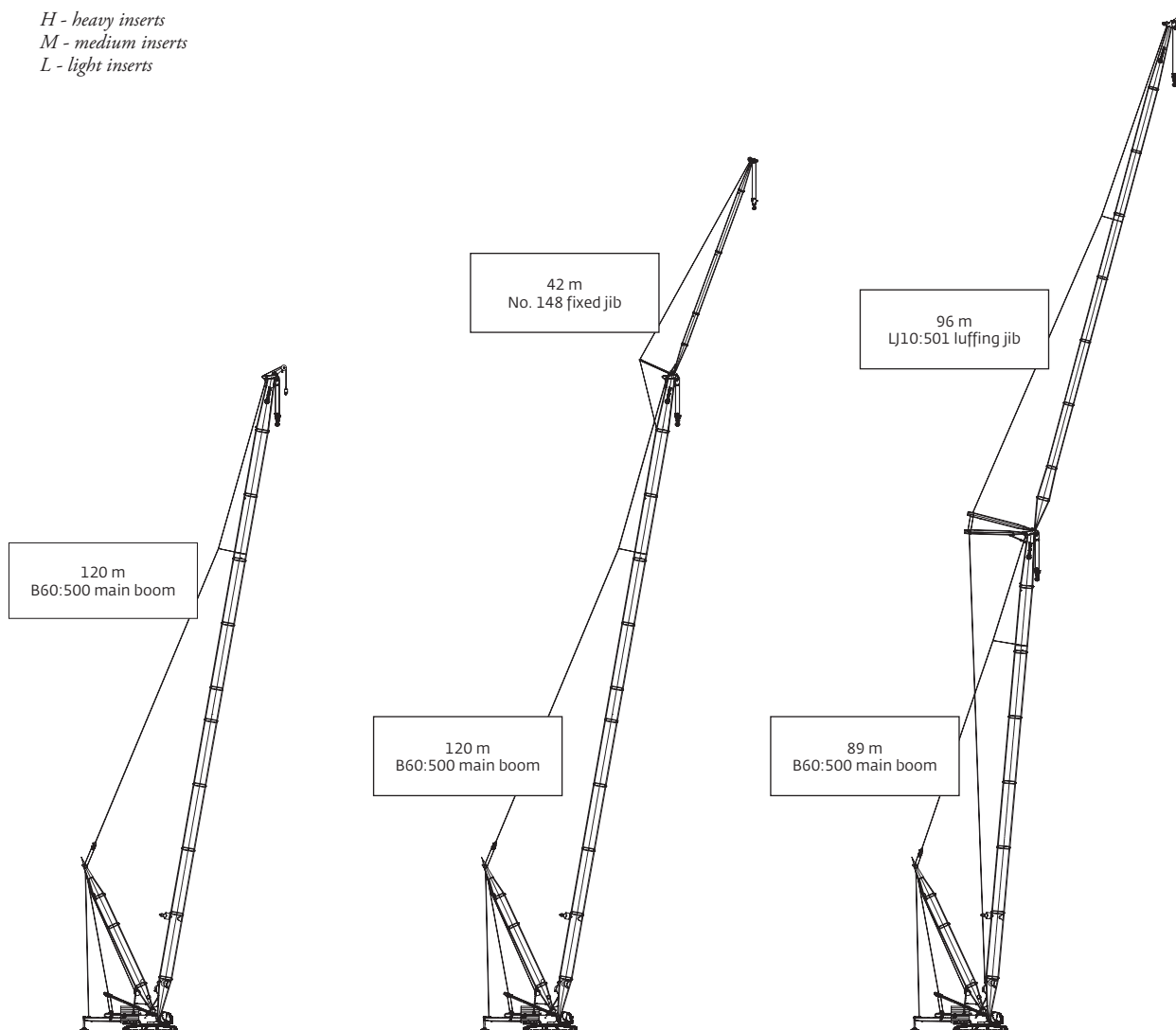

THIS CHART IS ONLY A GUIDE AND SHOULD NOT BE USED TO OPERATE THE CRANE.

The individual crane's load chart, operating instructions and other instructional plates must be read and understood prior to operating the crane

Main boom range diagram

VPC-MAX™

B60:500 boom with VPC-MAX™

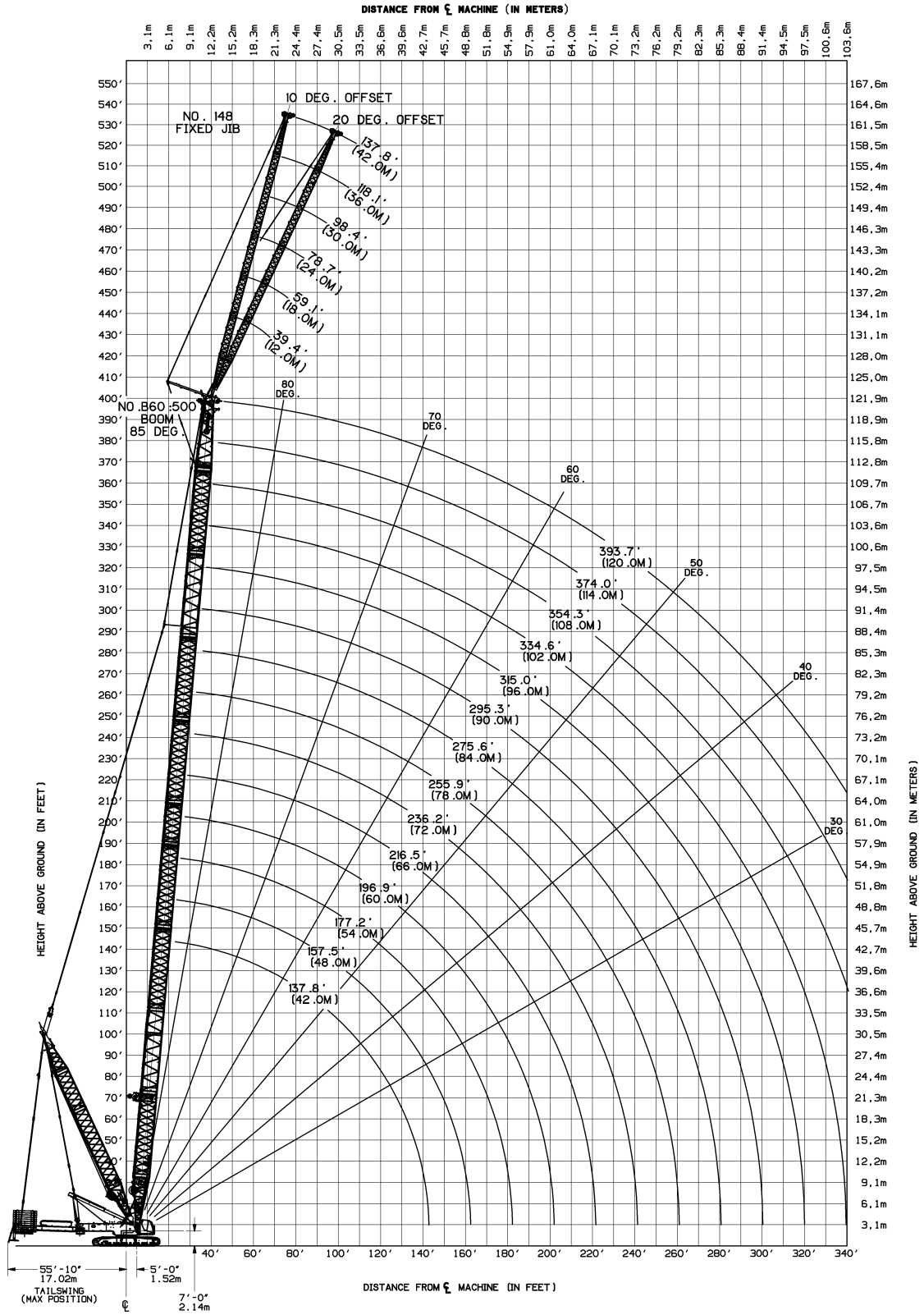

Main boom load charts

VPC-MAX™

B60:500 boom with VPC-MAX™														
215,2 t counterweight														
360° Rating														
Radius m	kg x 1000													
	Boom length m													
	42	48	54	60	66	72	78	84	90	96	102	108	114	120
7,3	300,0	278,0	251,2	—	—	—	—	—	—	—	—	—	—	—
8	300,0	278,0	251,2	226,8	—	—	—	—	—	—	—	—	—	—
9	300,0	278,0	251,2	226,8	204,1	—	—	—	—	—	—	—	—	—
10	292,4	276,0	251,2	226,8	204,1	176,9	147,3	—	—	—	—	—	—	—
11	279,3	266,0	251,0	226,8	204,1	176,9	147,3	125,0	104,9	90,4	—	—	—	—
12	267,5	255,4	243,2	226,8	204,1	176,9	147,3	125,0	104,9	90,4	76,2	—	—	—
14	246,6	236,3	225,9	214,4	202,4	176,9	147,3	125,0	104,9	90,4	76,2	66,8	58,6	51,4
16	233,2	222,6	210,7	200,6	190,9	175,2	147,3	125,0	104,9	90,4	76,2	66,8	58,6	51,4
18	232,1	221,6	204,5	188,3	179,8	169,8	147,3	125,0	104,9	90,4	76,2	66,8	58,6	51,4
20	206,3	206,7	204,3	186,7	170,3	161,4	147,3	125,0	104,9	90,4	76,2	66,8	58,6	51,4
22	182,4	182,3	182,9	182,5	170,7	155,3	146,1	125,0	104,9	90,4	76,2	66,8	58,6	51,4
24	163,3	163,1	163,3	163,1	163,4	155,3	144,2	125,0	104,9	90,4	76,2	66,8	58,6	51,4
26	147,6	147,4	147,5	147,0	147,0	146,5	140,5	124,9	104,8	90,4	76,2	66,8	58,5	51,3
28	134,3	134,1	134,3	133,8	133,7	133,1	133,6	122,8	103,7	90,4	76,2	66,8	58,5	51,3
30	123,1	122,9	123,0	122,5	122,5	121,8	121,6	118,3	100,8	90,4	76,2	66,8	58,4	51,2
34	105,1	104,8	104,9	104,4	104,4	103,7	103,4	102,7	94,9	90,4	75,6	64,3	57,7	50,8
38	91,2	90,9	91,0	90,5	90,4	89,8	89,5	88,8	88,5	87,8	72,7	59,9	55,2	49,9
42	—	79,9	80,0	79,5	79,4	78,7	78,4	77,7	77,6	76,9	68,5	55,9	51,6	47,2
46	—	70,9	71,0	70,5	70,4	69,7	69,4	68,7	68,6	67,9	64,8	52,3	48,4	44,3
50	—	—	63,5	63,0	63,0	62,3	62,0	61,2	61,1	60,4	60,3	49,0	45,4	41,7
54	—	—	—	56,7	56,7	56,0	55,7	55,0	54,8	54,1	53,9	46,1	42,7	39,2
58	—	—	—	51,3	51,3	50,6	50,3	49,6	49,5	48,7	48,5	43,5	40,3	36,9
62	—	—	—	—	46,6	45,9	45,7	44,9	44,8	44,1	43,8	41,2	38,1	34,9
66	—	—	—	—	—	41,9	41,6	40,9	40,8	40,0	39,4	39,1	36,2	33,0
70	—	—	—	—	—	38,2	38,0	37,3	37,2	36,4	35,5	35,5	34,3	31,1
74	—	—	—	—	—	—	34,8	34,1	34,0	33,3	32,2	32,3	30,7	27,7
78	—	—	—	—	—	—	—	31,2	31,2	30,4	29,4	29,4	27,6	24,6
82	—	—	—	—	—	—	—	28,6	28,6	27,9	27,0	26,8	24,9	22,0
86	—	—	—	—	—	—	—	—	26,2	25,5	25,1	24,6	22,6	19,6
90	—	—	—	—	—	—	—	—	—	23,4	23,2	22,5	20,6	17,6
94	—	—	—	—	—	—	—	—	—	21,4	21,3	20,6	18,9	15,8
98	—	—	—	—	—	—	—	—	—	—	19,5	18,8	17,5	14,2
102	—	—	—	—	—	—	—	—	—	—	—	17,2	16,4	12,8
106	—	—	—	—	—	—	—	—	—	—	—	—	15,4	11,7
110	—	—	—	—	—	—	—	—	—	—	—	—	14,0	10,2
114	—	—	—	—	—	—	—	—	—	—	—	—	—	8,6

For complete chart, refer to www.cranelibrary.com.

Fixed jib working range diagram

VPC-MAX™

No. 148 fixed jib on B60:500 boom with VPC-MAX™

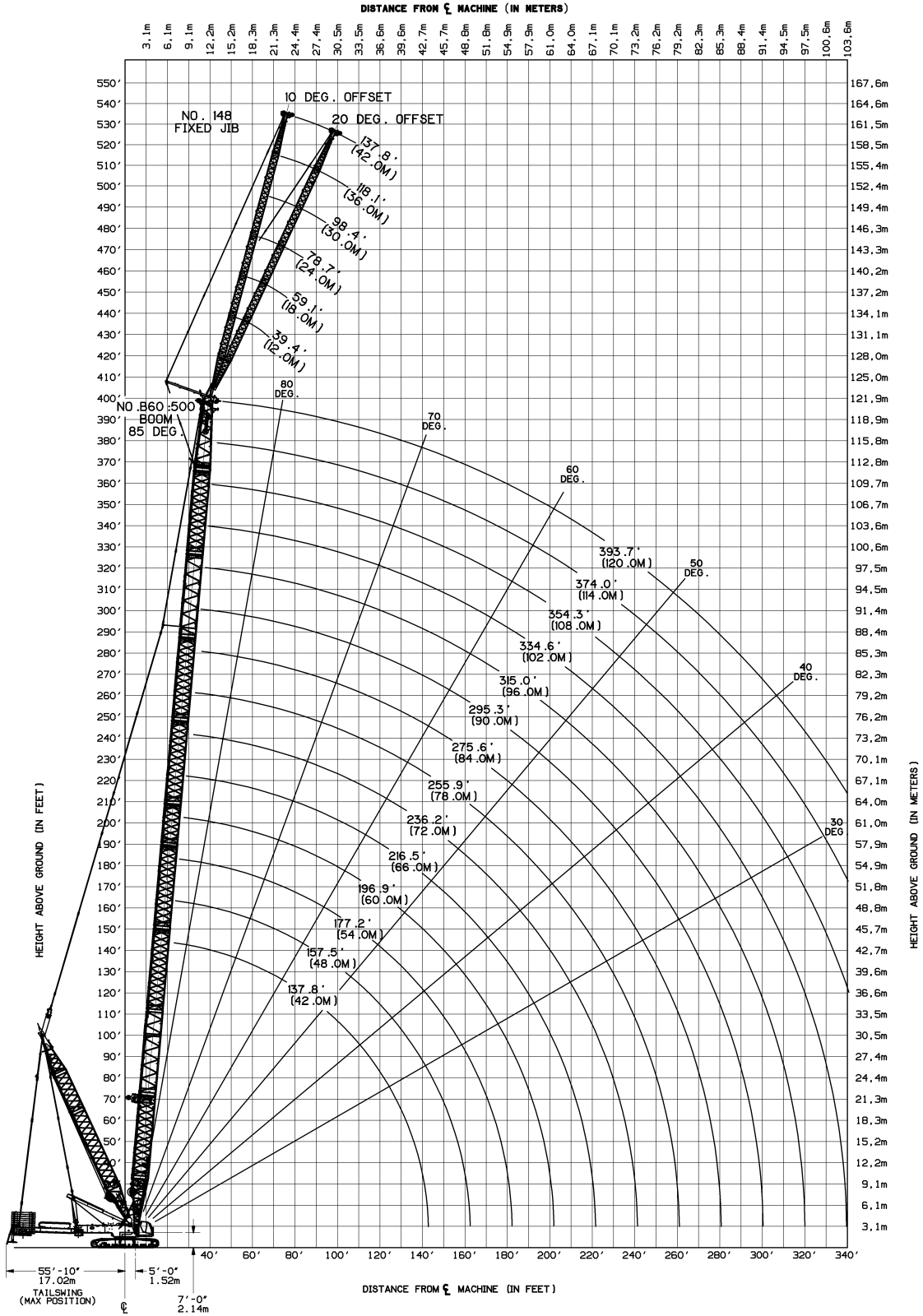

Fixed jib load charts

VPC-MAX™

No. 148 fixed jib on B60:500 boom with VPC-MAX™ Series 3

215 t counterweight

360° Rating

Radius m	10° offset				
	Boom Length m				
	42	60	78	96	108
12,0	65,0	65,0	—	—	—
16,0	65,0	65,0	64,1	57,9	44,8
20,0	64,7	65,0	63,6	57,0	44,8
24,0	57,8	64,8	63,1	56,2	44,8
28,0	51,4	61,2	62,6	55,4	44,8
32,0	46,3	55,7	61,2	54,6	43,4
36,0	42,2	51,1	57,1	53,5	40,3
40,0	38,9	47,3	53,5	50,4	37,5
44,0	36,1	44,1	50,2	47,5	34,9
48,0	33,8	41,3	47,4	44,8	32,6
52,0	32,1	38,9	44,9	42,5	30,5
56,0	—	36,8	42,5	40,4	28,7
60,0	—	35,0	40,5	38,5	27,0
64,0	—	33,4	38,6	36,9	25,5
68,0	—	32,2	37,0	35,4	24,2
72,0	—	—	35,6	34,1	22,9
76,0	—	—	33,5	31,7	21,9
80,0	—	—	30,7	29,0	21,0
84,0	—	—	28,2	26,6	20,1
88,0	—	—	25,9	24,3	19,4
92,0	—	—	—	22,3	18,8
96,0	—	—	—	20,4	18,3
100,0	—	—	—	18,7	17,2
108,0	—	—	—	—	14,6
116,0	—	—	—	—	12,0

kg x 1000

Radius m	20° offset				
	Boom Length m				
	42	60	78	96	108
16,0	56,6	60,9	58,5	51,1	—
20,0	50,2	55,3	57,6	50,5	43,5
24,0	45,3	50,6	54,3	49,9	43,5
28,0	41,3	46,8	50,7	49,4	42,6
32,0	38,1	43,6	47,5	48,8	39,8
36,0	35,4	40,8	44,8	46,7	37,2
40,0	33,2	38,4	42,4	44,4	34,8
44,0	31,4	36,4	40,3	42,2	32,6
48,0	30,0	34,6	38,5	40,2	30,6
52,0	—	33,1	36,8	38,3	28,8
56,0	—	31,7	35,4	36,7	27,1
60,0	—	30,6	34,1	35,3	25,7
64,0	—	29,7	32,9	34,0	24,3
68,0	—	—	31,9	32,9	23,1
72,0	—	—	31,0	32,0	22,0
76,0	—	—	30,2	30,6	21,1
80,0	—	—	29,6	28,0	20,2
84,0	—	—	—	24,5	19,5
88,0	—	—	—	22,4	18,8
92,0	—	—	—	20,5	18,3
96,0	—	—	—	—	17,8
100,0	—	—	—	—	17,3
108,0	—	—	—	—	14,7

Radius m	10° offset				
	Boom Length m				
	42	60	78	96	108
18,0	35,5	36,0	35,4	—	—
20,0	34,4	35,2	34,8	32,1	30,7
24,0	32,4	33,6	33,6	31,4	30,1
28,0	30,3	32,1	32,5	30,6	29,5
32,0	27,2	30,8	31,4	29,8	28,9
36,0	24,6	28,7	30,4	29,1	28,3
40,0	22,5	26,5	29,4	28,4	27,7
44,0	20,7	24,5	27,6	27,7	25,9
48,0	19,2	22,9	25,9	27,1	24,2
52,0	17,8	21,4	24,4	26,4	22,7
56,0	16,7	20,1	23,0	25,7	21,4
60,0	15,7	19,0	21,8	24,5	20,1
64,0	15,0	18,0	20,7	23,4	19,0
68,0	—	17,1	19,7	22,3	18,0
72,0	—	16,3	18,8	21,3	17,0
76,0	—	15,6	18,0	20,5	16,2
80,0	—	15,0	17,3	19,7	15,4
84,0	—	—	16,6	18,9	14,7
88,0	—	—	16,0	18,2	14,1
92,0	—	—	15,5	17,6	13,5
96,0	—	—	15,0	17,0	13,0
100,0	—	—	—	16,5	12,6
108,0	—	—	—	15,6	11,9
120,0	—	—	—	—	11,5
128,0	—	—	—	—	9,8

Radius m	20° offset				
	Boom Length m				
	42	60	78	96	108
20,0	28,4	29,9	—	—	—
24,0	25,4	27,3	29,6	28,1	27,2
28,0	23,0	25,1	27,5	27,6	26,8
32,0	21,0	23,2	25,7	26,4	26,4
36,0	19,3	21,6	24,1	24,9	25,3
40,0	17,9	20,3	22,7	23,6	24,1
44,0	16,7	19,1	21,4	22,5	23,0
48,0	15,7	18,0	20,3	21,4	22,0
52,0	14,8	17,0	19,3	20,5	20,8
56,0	14,1	16,2	18,4	19,6	19,7
60,0	13,5	15,5	17,6	18,9	18,7
64,0	—	14,8	16,8	18,1	17,7
68,0	—	14,3	16,2	17,5	16,8
72,0	—	13,8	15,6	16,9	16,0
76,0	—	13,4	15,1	16,3	15,3
78,0	—	—	14,6	15,8	14,6
82,0	—	—	14,1	15,4	14,0
84,0	—	—	13,9	14,9	13,4
88,0	—	—	13,6	14,5	12,9
92,0	—	—	13,3	14,2	12,5
100,0	—	—	—	13,9	12,1
108,0	—	—	—	13,4	11,5
120,0	—	—	—	—	11,3

For complete chart, refer to www.cranelibrary.com.

Fixed jib load charts

VPC-MAX™

No. 148 fixed jib on B60:500 boom with VPC-MAX™ Series 3

215 t counterweight

360° Rating

30 m jib length		10° offset				
Radius m	Boom Length m					
	42	60	78	96	108	
18,0	28,4	28,6	—	—	—	
20,0	27,5	27,9	27,6	26,5	25,3	
24,0	25,7	26,7	26,6	25,8	24,8	
28,0	23,9	25,4	25,7	25,2	24,2	
32,0	22,3	24,0	24,8	24,5	23,7	
36,0	20,9	22,8	23,7	23,8	23,2	
40,0	19,4	21,6	22,7	23,1	22,7	
44,0	17,7	20,5	21,8	22,4	22,2	
48,0	16,3	19,4	20,9	21,6	21,6	
52,0	15,1	18,1	20,1	20,9	20,5	
56,0	14,0	16,9	19,3	20,3	19,2	
60,0	13,1	15,8	18,2	19,6	18,1	
64,0	12,3	14,9	17,2	19,0	17,0	
68,0	11,6	14,1	16,3	18,3	16,1	
72,0	—	13,3	15,5	17,4	15,2	
76,0	—	12,7	14,8	16,7	14,4	
80,0	—	12,1	14,1	15,9	13,7	
84,0	—	11,6	13,5	15,3	13,0	
88,0	—	11,1	12,9	14,7	12,4	
92,0	—	—	12,4	14,1	11,9	
96,0	—	—	12,0	13,6	11,4	
100,0	—	—	11,6	13,1	11,0	
108,0	—	—	—	12,3	10,2	
116,0	—	—	—	11,5	9,7	
124,0	—	—	—	—	9,5	
132,0	—	—	—	—	9,3	

kg x 1000

30 m jib length		20° offset				
Radius m	Boom Length m					
	42	60	78	96	108	
24,0	22,2	23,4	23,4	—	—	
28,0	19,9	21,6	22,5	22,4	21,9	
32,0	18,1	19,9	21,1	21,7	21,4	
36,0	16,5	18,4	19,7	20,7	20,9	
40,0	15,2	17,1	18,5	19,6	19,9	
44,0	14,1	15,9	17,4	18,5	19,0	
48,0	13,1	15,0	16,4	17,6	18,1	
52,0	12,2	14,1	15,6	16,8	17,2	
56,0	11,5	13,3	14,8	16,0	16,5	
60,0	10,9	12,6	14,1	15,3	15,8	
64,0	10,3	12,0	13,4	14,7	15,2	
68,0	9,9	11,5	12,9	14,1	14,6	
72,0	—	11,0	12,3	13,5	14,1	
76,0	—	10,5	11,9	13,0	13,4	
80,0	—	10,2	11,4	12,6	12,8	
84,0	—	9,9	11,0	12,1	12,2	
88,0	—	—	10,7	11,7	11,7	
92,0	—	—	10,4	11,4	11,2	
96,0	—	—	10,1	11,1	10,8	
100,0	—	—	9,8	10,8	10,4	
108,0	—	—	—	10,2	9,8	
116,0	—	—	—	9,8	9,4	
124,0	—	—	—	—	9,2	

42 m jib length		10° offset				
Radius m	Boom Length m					
	42	60	78	96	108	
20,0	18,3	18,6	18,3	—	—	
24,0	16,8	17,5	17,5	16,9	15,3	
28,0	15,4	16,3	16,7	16,4	14,9	
32,0	14,1	15,2	15,8	15,9	14,5	
36,0	13,0	14,2	15,0	15,2	14,2	
40,0	11,9	13,3	14,1	14,6	13,8	
44,0	11,0	12,4	13,4	13,9	13,4	
48,0	10,1	11,6	12,6	13,3	12,8	
52,0	9,3	10,8	11,9	12,7	12,3	
56,0	8,6	10,1	11,3	12,1	11,8	
60,0	8,0	9,5	10,7	11,5	11,3	
64,0	7,4	8,9	10,1	11,0	10,9	
68,0	6,9	8,4	9,6	10,5	10,5	
72,0	6,4	7,9	9,1	10,0	10,0	
76,0	6,0	7,4	8,6	9,6	9,6	
80,0	5,7	7,0	8,2	9,2	9,2	
84,0	—	6,6	7,8	8,8	8,9	
88,0	—	6,3	7,4	8,4	8,5	
92,0	—	6,0	7,0	8,0	8,2	
96,0	—	5,7	6,7	7,7	7,9	
100,0	—	5,5	6,4	7,4	7,6	
108,0	—	—	5,9	6,8	7,0	
116,0	—	—	5,5	6,3	6,6	
124,0	—	—	—	5,9	6,1	
132,0	—	—	—	5,5	5,8	
140,0	—	—	—	—	5,4	

42 m jib length		20° offset				
Radius m	Boom Length m					
	42	60	78	96	108	
28,0	13,3	13,8	14,0	14,0	—	
32,0	12,3	13,0	13,3	13,4	12,7	
36,0	11,3	12,1	12,6	12,8	12,2	
40,0	10,5	11,4	12,0	12,3	11,8	
44,0	9,7	10,7	11,3	11,7	11,3	
48,0	9,0	10,0	10,8	11,2	10,9	
52,0	8,4	9,5	10,2	10,8	10,5	
56,0	7,8	8,9	9,7	10,3	10,1	
60,0	7,3	8,4	9,2	9,9	9,7	
64,0	6,8	7,9	8,8	9,5	9,3	
68,0	6,4	7,5	8,4	9,1	9,0	
72,0	6,0	7,1	8,0	8,7	8,6	
76,0	5,8	6,7	7,7	8,3	8,3	
80,0	5,5	6,4	7,3	8,0	8,1	
84,0	—	6,1	7,0	7,7	7,8	
88,0	—	5,9	6,7	7,4	7,5	
92,0	—	5,7	6,4	7,2	7,2	
96,0	—	5,5	6,2	6,9	7,0	
100,0	—	—	6,0	6,7	6,8	
108,0	—	—	5,6	6,2	6,4	
116,0	—	—	—	5,9	6,0	
124,0	—	—	—	5,6	5,7	
132,0	—	—	—	—	5,5	
140,0	—	—	—	—	5,4	

For complete chart, refer to www.cranelibrary.com.

Luffing jib working range diagram

VPC-MAX™

LJ10:501 luffing jib on B60:500 boom with VPC-MAX™

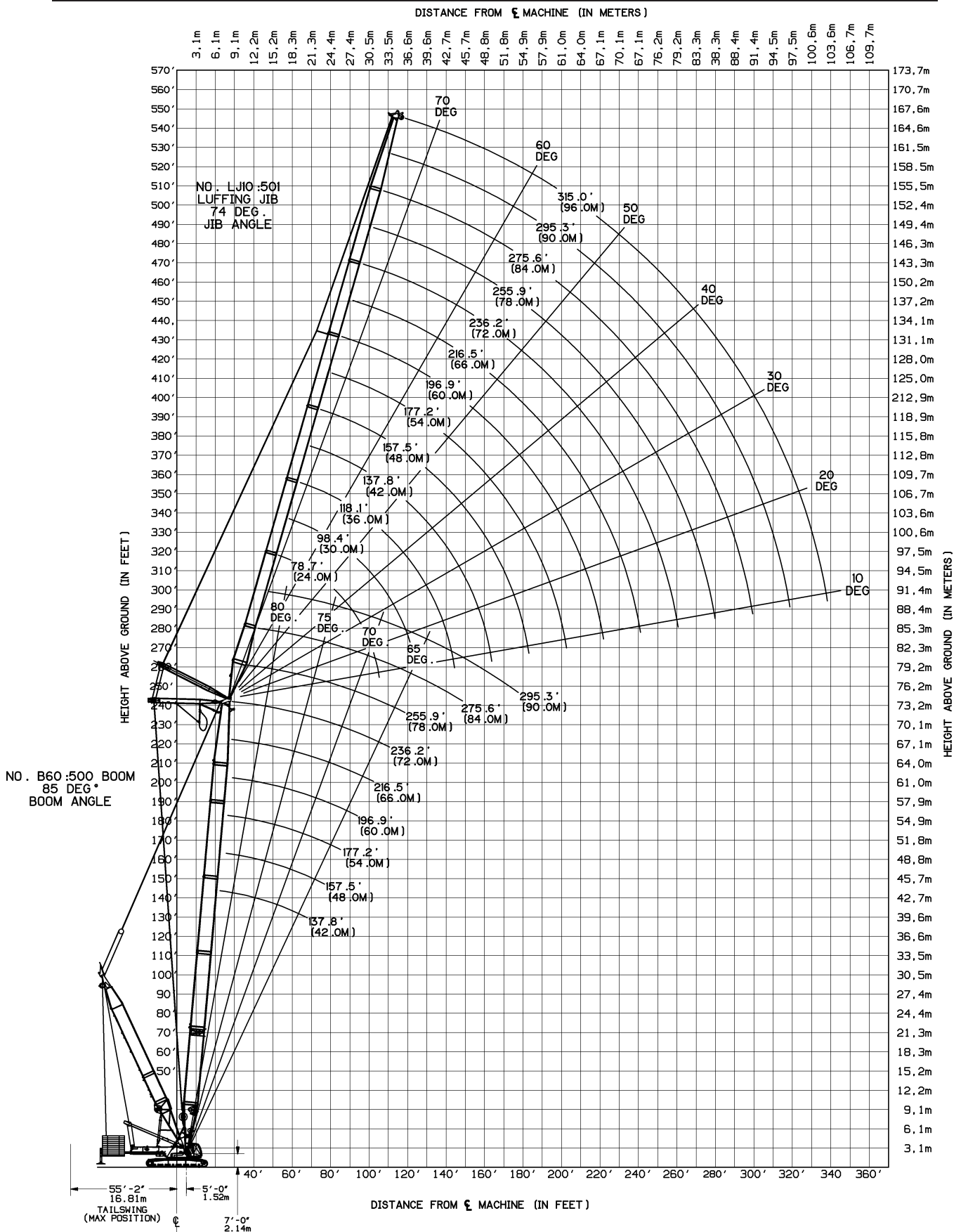

Luffing jib load charts

VPC-MAX™

LJ10:501 luffing jib on B60:500 boom with VPC-MAX™

215,2 t counterweight

360° Rating

kg x 1000

85° boom angle

42 m boom length					
Radius m	Boom length m				
	24	42	60	72	96
13,72	150,0	—	—	—	—
14	148,6	—	—	—	—
15	143,7	—	—	—	—
16	135,5	—	—	—	—
17	123,8	—	—	—	—
18	115,3	—	—	—	—
19	108,1	84,0	—	—	—
20	101,8	81,6	—	—	—
22	91,2	76,9	—	—	—
24	82,9	72,4	—	—	—
26	76,3	67,8	52,9	—	—
28	71,4	63,2	52,4	36,4	—
30	—	59,1	51,3	36,0	—
32	—	55,2	49,7	35,7	—
34	—	51,8	48,0	35,3	17,5
36	—	48,5	46,3	35,0	17,2
38	—	45,6	44,7	34,6	16,8
40	—	42,8	43,1	34,2	16,5
42	—	40,3	41,5	33,9	16,2
44	—	38,0	39,9	33,5	15,9
46	—	35,7	38,4	32,5	15,6
48	—	—	36,7	31,4	15,2
50	—	—	35,1	30,2	14,9
54	—	—	31,4	27,7	14,4
58	—	—	28,1	25,3	13,9
62	—	—	24,6	22,8	13,4
66	—	—	—	20,4	13,0
70	—	—	—	18,0	12,6
74	—	—	—	15,8	12,2
78	—	—	—	—	11,9
82	—	—	—	—	11,6
86	—	—	—	—	11,4
90	—	—	—	—	10,5
94	—	—	—	—	8,5
98	—	—	—	—	5,3

54 m boom length					
Radius m	Boom length m				
	24	42	60	72	96
15,2	125,6	—	—	—	—
16	120,1	—	—	—	—
17	112,8	—	—	—	—
18	105,5	—	—	—	—
19	98,9	—	—	—	—
20	93,3	78,8	—	—	—
22	84,0	75,0	—	—	—
24	76,6	71,2	—	—	—
26	70,7	67,5	46,3	—	—
28	66,1	63,7	46,2	—	—
30	63,3	59,2	46,0	32,6	—
32	—	55,0	45,8	32,4	—
34	—	51,5	45,6	32,2	—
36	—	48,5	44,7	31,9	16,2
38	—	45,9	43,2	31,7	16,0
40	—	43,7	41,8	31,4	15,7
42	—	41,4	40,2	31,2	15,5
44	—	39,0	38,2	30,9	15,2
46	—	36,9	36,4	30,6	14,9
48	—	34,0	34,7	30,3	14,7
50	—	—	33,3	29,4	14,5
54	—	—	30,7	27,2	14,0
58	—	—	27,9	25,0	13,5
62	—	—	25,7	22,7	13,1
66	—	—	—	20,5	12,7
70	—	—	—	18,2	12,3
74	—	—	—	16,1	12,0
78	—	—	—	—	11,7
82	—	—	—	—	11,4
86	—	—	—	—	11,2
90	—	—	—	—	10,8
94	—	—	—	—	8,7
98	—	—	—	—	5,8

For complete chart, refer to www.cranelibrary.com.

Luffing jib load charts

VPC-MAX™

LJ10:501 luffing jib on B60:500 boom with VPC-MAX™

215,2 counterweight

360° Rating

kg x 1000

85° boom angle

66 m boom length					
Radius m	Boom length m				
	24	42	60	72	96
16,7	99,5	—	—	—	—
17	98,9	—	—	—	—
18	96,6	—	—	—	—
19	92,7	—	—	—	—
20	87,1	—	—	—	—
22	78,7	62,7	—	—	—
24	72,0	62,3	—	—	—
26	66,7	61,5	39,3	—	—
28	62,4	59,1	39,2	—	—
30	59,2	54,7	39,0	28,6	—
32	—	51,1	38,8	28,5	—
34	—	48,0	38,6	28,4	—
36	—	45,3	38,2	28,2	—
38	—	43,0	37,5	28,0	14,7
40	—	41,0	35,9	27,8	14,6
42	—	39,3	34,3	27,6	14,4
44	—	37,9	32,7	27,3	14,2
46	—	36,4	31,2	27,1	14,0
48	—	35,1	29,7	26,2	13,8
50	—	—	28,3	25,1	13,6
54	—	—	25,7	23,2	13,2
58	—	—	23,5	21,3	12,9
62	—	—	21,7	19,6	12,5
66	—	—	20,5	18,1	12,2
70	—	—	—	16,8	11,8
74	—	—	—	15,8	11,5
78	—	—	—	14,5	11,2
82	—	—	—	—	10,5
86	—	—	—	—	9,9
90	—	—	—	—	9,3
94	—	—	—	—	8,5
98	—	—	—	—	6,1
90	—	—	—	—	10,5
94	—	—	—	—	8,5
98	—	—	—	—	5,3

84 m boom length					
Radius m	Boom length m				
	24	42	54	66	78
18,3	60,5	—	—	—	—
19	60,2	—	—	—	—
20	59,7	—	—	—	—
22	58,4	—	—	—	—
24	56,9	40,8	—	—	—
26	55,5	40,3	31,6	—	—
28	53,6	39,7	31,4	—	—
30	50,6	39,0	31,1	24,4	—
32	46,8	38,2	30,7	24,2	18,5
34	—	37,3	30,3	24,0	18,5
36	—	35,5	29,9	23,8	18,3
38	—	33,7	29,3	23,6	18,2
40	—	32,0	28,1	23,3	18,0
42	—	30,4	26,8	23,0	17,9
44	—	29,0	25,6	22,3	17,7
46	—	27,7	24,4	21,4	17,5
48	—	26,7	23,3	20,5	17,3
50	—	26,1	22,3	19,7	16,9
54	—	—	20,4	18,1	15,7
58	—	—	18,9	16,7	14,5
62	—	—	18,1	15,4	13,5
66	—	—	—	14,3	12,5
70	—	—	—	13,5	11,6
74	—	—	—	12,9	10,8
78	—	—	—	—	10,1
82	—	—	—	—	9,6
86	—	—	—	—	8,9

For complete chart, refer to www.cranelibrary.com.

Upperworks

Engine

Cummins Model QSG-12 diesel, 11.8 liter displacement, inline 6 cylinder, 336 kW @1800 governed RPM. Emissions Level: U.S. EPA/ CARB Tier 4 Final/ EU Stage IV Compliant. Included are engine block heater (240 V), engine oil pan heater (240 V), air intake grid heater, disconnect clutch for cold weather starting, exhaust after treatment, variable speed hydraulic cooling fan, hydraulic oil cooler, radiator, charge air cooler, and fuel cooler. Also included are two 12 volt maintenance-free, Group 8D batteries, 1375 CCA at -18°C, 24 volt starting and 110 amp alternator. Single diesel fuel tank is 965 L capacity complete with physical level indicator on tank and electronic level indicator in the operator's cabin.

Optional: Cold-weather package with heater for fluids.

Crane Control System

The Crane Control System offers a user-friendly interface, two full graphic displays mounted horizontally for better visibility, a jog dial for easier data input and ergonomic joysticks.

Hydraulic system

Efficient, independent, full power multi-functional control is achieved in all operating modes through a combination of open and closed loop system optimized by Manitowoc's proprietary onboard Crane Control System.

552 L hydraulic reservoir is equipped with sight gauge, breather, clean out access, 100 micron mesh internal strainers, and 40 micron inlet screens. Primary filtration system is equipped with 8 micron absolute filters.

Drums

Basic machine is equipped with an independent main drum assembly and independent luffing/aux drum assembly mounted in the boom butt. Each drum is driven by a variable-displacement hydraulic motor through a planetary reduction. Drums are grooved for 28 mm wire rope. Main hoist has 16 670 kg linepull on all layers with a 700 mm drum diameter; luffing/aux drum has 13 610 kg linepull on all layers with a 600 mm drum diameter.

Powered hoisting/ lowering operation with automatic spring applied, hydraulically released multi-disc brakes, and drum rotation indicators standard.

Basic machine is equipped with a rigging winch mounted in the boom butt. Drum utilizes 8 mm wire rope with 1 021 kg max linepull capability.

- Optional: auxiliary hoists – Rotating bed mounted, can be fitted with one or two auxiliary drums grooved for 28 mm wire rope, and both having 16 670 kg linepull on all layers. These two drums can be used independently or in tandem to suit a variety of lift applications.
- Optional: freefall hoists – Rotating bed mounted, can be fitted with one or two free fall equipped drums grooved for 28 mm wire rope. Freefall function is controlled by wet disk brake manually applied by foot pedal with locking latch in operator's cabin. Operator may select free-fall or powered lowering mode using a selector switch in the cab.

Moving mast system

Independent boom hoist consists of a single drum grooved for 26 mm diameter wire rope. Includes 425 m of 26 mm diameter wire rope to accommodate 24 part live mast reeving. Drum is powered by a variable displacement hydraulic motor coupled to an internal spring applied, hydraulically released multi-disc brake multi-disc brake and planetary gearbox equipped with ratcheting pawl and drum rotation indicators. Live mast system assembly module includes live mast, boom hoist drum and rear sheave nest. The assembly weighs 9000 kg and may be removed from the rotating bed for an upperworks module transport weight reduction.

Swing System

Rotating bed mounted independent swing is powered by a fixed displacement hydraulic motor coupled to an internal brake and planetary reduction engaging a 3 m diameter triple row roller turntable bearing.

Swing system maximum speed: 2,0 rpm.

Boom support system

Moving mast is 9,1 m long and connects the boom hoist reeving to the high strength steel boom suspension strap rigging. When used with optional self-erect package, the mast with integral hydraulic cylinder is used for handling crawlers, counterweight and boom sections.

Spring cushioned boom stop and automatic electrical boom stop are standard.

Variable position counterweight

The Variable Position Counterweight™ (VPC™) system, with only rotating bed counterweight, maintains optimum crane stability by automatically positioning crane counterweight based on boom length and load radius. No carbody counterweight is required.

The crane can be equipped with 175 200 kg of upperworks counterweight made up of a single piece counterweight tray and sixteen 10 t counterweight boxes or with 215 200 kg of upperworks counterweight with 2010 t counterweight boxes. Left and right side counterweights are interchangeable and common with the Model MLC650 counterweight.

Vision operator's cab

The Vision Cab™ is a fully enclosed and insulated galvanized steel module mounted to the left front corner of rotating bed. Module is equipped with power tilt, sliding door, large safety glass windows, front and roof windshield wipers, dome light, sun visor and shade, fire extinguisher, air conditioning, swing and travel alarms, and radio/CD player. Operator's station swings over front of rotating bed for transport.

- Optional: Nylon protective window covers.

Specifications

Lowerworks



Carbody

Connects rotating bed and crawler frames. Each frame is mounted to the carbody with FACT connection system and hydraulic power-actuated pins.



Crawlers

Crawler assemblies are 9,7 m long with 1,2 m wide cast steel crawler pads and automatically lubricated intermediate rollers. Left and right side crawlers are interchangeable to provide assembly/disassembly flexibility on Jobsites. Each crawler is powered independently by a variable displacement hydraulic motor connected via screw together hydraulic quick disconnects. Crawlers provide ample tractive effort for travel and counter-rotating with full rated load.

Maximum ground speed of 1,3 kph.

- Optional: 1,5 m wide treads.

Attachments



No. 500 boom

The liftcrane is equipped with 30 m No. 500 basic boom consisting of 8 m butt, 12 m insert with luffing/aux hoist sheaves and 10 m top with eight 762 mm diameter sheaves with tapered roller bearings. Includes rope guides, boom hoist wire rope, boom angle indicator and hook and weight ball. The boom utilizes Manitowoc's exclusive FACT boom connection system. Includes spring cushioned boom stop, automatic boom stop, hydraulically powered boom hinge system including cylinder, hydraulic piping, operating controls, and locking device.

- Optional: 6 m, 12 m, and 12 m with wire rope suspension No. 500 boom inserts with steel boom suspension straps for a maximum boom length of 102 m.

Detachable upper boom point with 762 mm diameter sheave with tapered roller bearings grooved for 28 mm rope with rope guard.



No. 148 fixed jib

12 m No. 148 fixed jib including pin 6 m butt, 6 m top, jib strut and mounting hardware.

- Optional: 6 m and 12 m No. 148 inserts with pin connectors and pendants for a maximum jib length of 42 m.



No. 501 luffing jib

24 m No. 501 luffing jib includes 6 m butt, 6 m transition insert, 12 m top, basic straps, main strut, jib strut, backstay straps and jib point guide wheel.

- Optional: 6 m and 12 m No. 501 luffing jib inserts with steel boom suspension straps for a maximum luffing jib length of 96 m.



VPC-MAX

The VPC-MAX components include:

- 30 m of No. 503 mast consisting of a 6 m butt, 6 m insert, 12 m insert with sheave, and 6 m top.
- One additional swing drive (for a total of two) mounted on the front of the rotating bed. Each swing drive is powered by a fixed-displacement hydraulic motor coupled to a planetary reduction gearbox and internal spring applied, hydraulically released multi-disc brake.

- VPC-MAX™ counterweight actuator assembly consisting of a high strength steel frame, 2 drive assemblies, hydraulic piping and controls.
- VPC-MAX™ counterweight beam assembly consisting of a high strength steel frame fitted with gear teeth and roller path prepared to receive VPC-MAX™ actuator assembly.
- The base machine VPC actuator assembly, crane counterweight tray and counterweight are utilized.

The VPC-MAX system maintains optimum crane stability by automatically positioning crane counterweight behind the crane's centerline of rotation based on lifted load, boom length and load radius.

Optional equipment

- Self erect system including carbody jacking cylinders with pads, self erect cylinder fitted to the live mast assembly and crawler handling chains.
- Hydraulic Test Kit: recommended to properly analyze the performance of the CCS control system.
- Service Interval Kits for the regularly scheduled maintenance of general crane operations.
- Special paint color(s) other than Manitowoc standard red and black.
- Custom vinyl decal(s) of customer name and/or logo from artwork supplied by customer.
- Export Packaging: basic crane, boom and jib sections.
- Additional load blocks available upon request.

Notes

Manitowoc Cranes

Regional headquarters

Americas

Manitowoc, Wisconsin, USA

Tel: +1 920 684 6621

Fax: +1 920 683 6277

Shady Grove, Pennsylvania, USA

Tel: +1 717 597 8121

Fax: +1 717 597 4062

Europe and Africa

Dardilly, France - TOWERS

Tel: +33 (0)4 72 18 20 20

Fax: +33 (0)4 72 18 20 00

Wilhelmshaven, Germany - MOBILE

Tel: +49 (0) 4421 294 0

Fax: +49 (0) 4421 294 4301

China

Shanghai, China

Tel: +86 21 6457 0066

Fax: +86 21 6457

4955

Middle East and Greater Asia-Pacific

Singapore

Tel: +65 6264 1188

Fax: +65 6862 4040

Dubai, UAE

Tel: +971 4 8862677

Fax: +971 4 8862678/79



This document is non-contractual. Constant improvement and engineering progress make it necessary that we reserve the right to make specification, equipment, and price changes without notice. Illustrations shown may include optional equipment and accessories and may not include all standard equipment.