

# Grove RT9130E-2

## Product Guide



120 t



48,8 m



11,0 - 18,0 m



85,0 m



**Rough Terrain Crane • Geländekran  
Grue Tout-Terrain • Grúa Todo Terreno  
Autogru Fuoristrada • Grua RT**

**Кран для использования на пересеченной местности**

## Features • Besonderheiten • Caractéristiques • Características Caratteristiche • Características • Особенности



- **MEGAFORM™ boom** - The Grove MEGAFORM™ boom shape eliminates weight and increases capacity compared to conventional shapes. Large wear pads provide superior boom alignment when telescoping, and allow an excellent transition of weights between sections.
- **MEGAFORM™ Ausleger** - Grove Durch das spezielle Design des MEGAFORM™-Auslegers kann im Vergleich zu konventionellen Auslegern Gewicht eingespart und Leistung gesteigert werden. Große Gleitstücke sorgen für eine optimale Ausrichtung des Auslegers beim Ausfahren und ermöglichen eine ausgezeichnete Verteilung des Gewichts zwischen den Teleskopteilen.
- **Flèche MEGAFORM™** - La forme de la flèche Grove MEGAFORM™ réduit le poids et augmente la capacité par rapport aux formes conventionnelles. Les grandes plaques d'usure optimisent l'alignement de la flèche lors du télescopage et permettent une excellente répartition des charges entre les sections.
- **Pluma MEGAFORM™** - La pluma con forma Grove MEGAFORM™ reduce peso y aumenta la capacidad en comparación con las formas convencionales. Las grandes placas de desgaste proporcionan una mejor alineación de la pluma durante la extensión y permiten una excelente transición de pesos entre las secciones.
- **Braccio MEGAFORM™** - La sezione del braccio Grove MEGAFORM™ riduce il peso e aumenta la capacità rispetto alle configurazioni convenzionali. I pattini di scorrimento di grandi dimensioni garantiscono un allineamento del braccio telescopico di livello superiore e consentono una transizione eccellente dei pesi tra le sezioni.
- **Lança MEGAFORM™** - A forma MEGAFORM™ das lanças Grove proporciona uma redução de peso e um aumento de capacidade quando comparado com as formas tradicionais. As grandes placas de desgaste fornecem o melhor alinhamento da lança quando da telescopagem, permitindo uma excelente repartição dos pesos entre as secções.
- **Кран на вседорожном шасси MEGAFORM™ boom** - Модель MEGAFORM™ boom снижает вес и увеличивает грузоподъемность по сравнению со стандартными моделями. Большая поворотная опора обеспечивает идеальное выравнивание стрелы во время юстировки и превосходное перемещение грузов между секциями.

- **Extension:** A 11-18 m offsettable bi-fold lattice swingaway extension and two 8 m inserts give the RT9130E-2 a maximum tip height of 85 m. A hydraulically offsettable bi-fold lattice swingaway is also available, and conveniently offsets from 0° to 40° from the operator's cab.
- **Verlängerung:** Durch eine 11-18 m lange abwinkelbare Doppelklappspitze in Gitterbauweise und zwei 8 m lange Zwischenstücke bietet der RT9130E-2 eine maximale Arbeitshöhe von 85 m. Außerdem ist eine hydraulisch abwinkelbare Doppelklappspitze in Gitterbauweise mit zweckmäßigen Winkelstellungen von 0° bis 40° im Verhältnis zur Bedienerkabine verfügbar.
- **Extension:** l'extension en treillis escamotable à double repli et déportable, de 11-18 m, et les deux rallonges de 8 m permettent d'obtenir avec la RT9130E-2 une hauteur maximale de la tête de flèche de 85 m. Une rallonge hydraulique en treillis escamotable à double repli et déportable est aussi disponible et permet un déport de 0° à 40° par rapport à la cabine de l'opérateur.
- **Extensión:** Una extensión de plumín de celosía articulado de 2 secciones abatible de 11-18 m y dos estabilizadores de 8 m aportan a la RT9130E-2 una altura máxima en punta de 85 m. También hay disponible un plumín de celosía articulado de 2 secciones y abatible hidráulicamente que puede inclinarse de 0° a 40° desde de la cabina del operario.
- **Prolonghe:** Un falcone tralicciato inclinabile da 11-18 m e due inserti da 8 m forniscono un'altezza massima in punta di 85 m. E' anche disponibile un falcone tralicciato ripieghevole, che si inclina idraulicamente da 0° a 40° dalla cabina operatore.
- **Extensão:** Uma extensão da estrutura oscilante conjugada compensável de 11-18 m e dois acessórios de 8 m proporcionam ao RT9130E-2 uma altura máxima da ponta de 85 m. Está também disponível uma estrutura oscilante conjugada compensável hidráulicamente e é compensada de 0° a 40° a partir da cabine do operador.
- **Удлинитель:** двухсекционный поворотный решетчатый удлинитель длиной 11-18 м и две вставки длиной 8 м обеспечивают RT9130E-2 максимальную высоту оголовка 85 м. Также предлагается двухсекционный решетчатый удлинитель с управляемым из кабины оператора гидравлическим поворотным устройством на 0°-40°.



- **Full vision cab:** New full-vision cab, all-steel fabricated with acoustical lining and tinted safety glass throughout. The cab tilts up to 20° providing the operator additional comfort when working at long boom and extension lengths.
- **Rundumsichtkabine:** Neue Rundumsichtkabine, in Stahlblech ausgeführt mit Schalldämmung und rundum mit getöntem Sicherheitsglas. Die Kabine lässt sich um bis zu 20° neigen und bietet dem Bediener so zusätzlichen Komfort bei Arbeiten mit langem Ausleger und Verlängerung.
- **Cabine panoramique:** Nouvelle cabine panoramique tout acier, fabriquée avec une isolation sonore et un vitrage teinté de sécurité sur tout le pourtour. La cabine bascule jusqu'à 20° pour apporter à l'opérateur un confort supplémentaire lors du travail avec de grandes longueurs de flèche et d'extension.
- **Cabina de visión panorámica:** nueva cabina de visión panorámica, fabricada totalmente en acero con revestimiento acústico y cristal de seguridad en toda ella. La cabina se inclina hasta 20° para mayor comodidad del operario cuando trabaja con la pluma larga y tramos de extensión.
- **Cabina "Full Vision":** Nuova cabina ad ampia visibilità, completamente realizzata in acciaio con rivestimento acustico e vetri di sicurezza colorati. La cabina si inclina fino a 20° per fornire all'operatore ulteriore comfort quando lavora con braccio esteso e prolunghe del braccio.
- **Cabina panorâmica:** Nova cabina panorâmica, que permite uma visibilidade completa, fabricada integralmente em aço com isolamento acústico e vidro de segurança escurecido. Cabina inclinável até 20°, permitindo ao operador maior conforto quando a grua está a trabalhar com comprimentos de lança maiores ou com as extensões adicionais.
- **Кабина с полным обзором:** новая кабина с полным обзором, полностью стальная с полной акустической облицовкой и тонированным предохранительным стеклом. Кабина наклоняется до 20°, обеспечивая оператору дополнительный комфорт при работе с длинной стрелой и вставкой.

# Features • Besonderheiten • Caractéristiques • Carasterísticas Caratteristiche • Características • Особенности

- **Inverted outrigger jacks:** allows to protect the cylinder rod from sand, dust, oils and various elements you can find on a jobsite and increases seal life. The outriggers can be spread in 3 different positions: fully retracted, 50 % and 100 % open.
- **innen liegende Abstützzylinder:** schützt die Kolbenstange vor Sand, Staub, Öl und verschiedenen anderen Einflüssen auf der Baustelle. Die Abstützträger können in 3 Stellungen fixiert werden: Voll eingefahren, 50 % und 100 %.
- **Système de calage inversé :** permet de protéger la tige de vérin du sable, de la poussière, de la graisse et de tout autre élément courant sur un site de chantier. Le système de calage peut être placé dans 3 positions : entièrement rentré, 50 % et 100 %.
- **Estabilizadores invertidos:** permite proteger el vástago del cilindro, de la arena, el polvo, aceites y diversos elementos que se pueden encontrar en el lugar de trabajo. Los estabilizadores se pueden fijar en 3 posiciones diferentes: Totalmente plegados, 50% y 100%.
- **Stabilizzatori a steli rovesciati:** consentono di proteggere lo stelo del cilindro dagli urti oltre che dalla sabbia, polvere, olio e vari elementi tipici dei cantieri. Gli stabilizzatori possono essere estesi in 3 configurazioni diverse: Completamente retratti, 50% e 100%.
- **Estabilizadores invertidos:** permite proteger a haste do cilindro da areia, do pó, dos óleos e dos vários elementos que se podem encontrar num local de trabalho. Os estabilizadores podem ser fixos em 3 posições diferentes: totalmente fechados, abertos a 50% e abertos a 100%.
- **Перевернутые цилиндры опор:** способствуют защите штока цилиндра от попадания песка, пыли и прочих веществ, имеющихся на рабочем месте. Выносные опоры можно устанавливать в 3 различных положениях: выдвинув полностью, на 50% или 100%.



- **Removable outrigger boxes:** Removable front and rear outrigger boxes provide weight reduction for easier transport. Including the removable counterweight and auxiliary hoist, the RT9130E-2 can easily self-remove close to 29.000 kg.
- **Abnehmbare Abstützträger:** Abnehmbare Abstützträger vorne und hinten zur Gewichtsreduzierung für den einfachen Transport. Einschließlich dem abnehmbaren Gegengewicht und Hilfshubwerk kann der RT9130E-2 leicht bis zu 29.000 kg selbst abbauen.
- **Stabilisateurs amovibles :** Les stabilisateurs avant et arrière amovibles permettent de réduire le poids pour faciliter le transport. Avec le palan auxiliaire et le contrepoids amovibles, la RT9130E-2 peut facilement peser près de 29.000 kg de moins.
- **Cajas de los estabilizadores extraíbles:** Las cajas extraíbles de los estabilizadores delanteros y traseros permiten reducir el peso para facilitar el transporte. Incluyendo el contrapeso y el cabrestante auxiliar, la RT9130E-2 puede reducir su peso en casi 29.000 kg.
- **Scatola stabilizzatori rimovibili:** Gli stabilizzatori rimovibili anteriori e posteriori riducono il peso della macchina e facilitano il trasporto. Includendo il contrappeso e l'argano ausiliario, la RT9130E-2 può rimuovere da sola fino a 29.000 kg.
- **Caixas do estabilizador amovíveis:** As caixas do estabilizador amovíveis frontal e traseira reduzem o peso para um transporte mais fácil. Incluindo o contrapeso amovível e o guincho auxiliar, o RT9130E-2 pode ser facilmente autorremovido com cerca de 29.000 kg.
- **Съемные выносные опоры:** передние и задние выносные опоры выполнены съемными для уменьшения веса и упрощения транспортировки. Входящие в комплектацию съемный противовес и вспомогательная лебедка позволяют RT9130E-2 самостоятельно снимать грузы до 29 000 кг.



**CraneSTAR**  
EQUIPPED

- **CraneSTAR** is an exclusive and innovative crane asset management system that helps improve your profitability and reduce costs by remotely monitoring critical crane data. Visit [www.cranestar.com](http://www.cranestar.com) for more information.
- **CraneSTAR** ist ein exklusives und innovatives Kran-Überwachungssystem, das Ihnen hilft, per Fernüberwachung Krandaten abzurufen und somit Ihre Profitabilität zu steigern und Kosten zu reduzieren. Mehr Informationen unter [www.cranestar.com](http://www.cranestar.com).
- **CraneSTAR** est un système exclusif et innovant de gestion de parc de grues qui contribue à améliorer la rentabilité et à réduire les coûts en surveillant à distance les données cruciales des grues. Visitez [www.cranestar.com](http://www.cranestar.com) plus de plus amples informations.
- **CraneSTAR** es un sistema exclusivo e innovador de gestión de flotas de grúas que ayuda a mejorar la rentabilidad y reducir los costes controlando a distancia los datos críticos de la grúa. Más información en [www.cranestar.com](http://www.cranestar.com)
- **CraneSTAR** è un esclusivo e innovativo sistema di gestione del parco mezzi che aiuta a migliorare la redditività e ridurre i costi attraverso il monitoraggio remoto dei dati critici dell'autogrù. Visitare il sito [www.cranestar.com](http://www.cranestar.com) per ulteriori informazioni.
- **CraneSTAR** é um sistema exclusivo e inovador de gestão de frotas de gruas que ajuda a melhorar a sua rentabilidade e a reduzir os custos ao monitorizar à distância os dados mais importantes da grua. Mais informação em [www.cranestar.com](http://www.cranestar.com).
- **CraneSTAR** - это эксклюзивная инновационная система управления ресурсом подъемного крана, которая позволяет увеличить производительность и сократить расходы путем постоянного дистанционного наблюдения за критическими данными подъемного крана. Посетите сайт [www.cranestar.com](http://www.cranestar.com) для получения дополнительной информации.

# Contents • Inhalt • Contenu • Contenido Contenuto • Índice • Содержание

Features • Besonderheiten • Caractéristiques • Caratteristiche Características • Características • Освоенности	2
Dimensions • Abmessungen • Encombrement • Dimensiones • Dimensioni • Dimensões • Размеры	5
Data • Daten • Caractéristiques • Datos • Dati • Características • Данные	6
Load charts • Traglasten • Capacités de levage • Capacidades • Capacità • Diagramas de carga Таблицы грузоподъемности	
Working Range • Arbeitsbereiche • Diagramme de levage • Gama de trabajo • Area di lavoro • Intervalo de funcionamento • Грузовысотные характеристики	8
Telescopic Boom • Teleskopausleger • Flèche principale • Pluma telescópica • Braccio telescopico Lança telescópica • Телескопическая стрела	9
Swingaway • Klappspitze • Extension treillis • Plumín • Jib • Extensões- Jib • Откидной удлинитель стрелы	11
Weight reductions • Gewichte der Lastaufnahmemittel • Reductions de charge Reducciones de peso • Riduzioni di peso • Reduções de peso • Снижение веса	14
Notes • Hinweise • Notes • Notas • Note • Notas • Примечания	15
Specification	16
Technische Daten	17
Caractéristiques techniques	18
Características	19
Caratteristiche tecniche	20
Características técnicas	21
Технические характеристики	22
Symbols • Symbolerklärung • Glossaire des symboles • Glosario de símbolos • Glossario dei simboli • Símbolos Символы	23



Manitowoc Crane Care is the Manitowoc's unparalleled product support organisation. ManitoWoc Crane Care combines all aspects of parts, service, technical documentation, technical support and training into one organisation. The program includes all of the Manitowoc's brands, which include, Potain, Grove, ManitoWoc and National Crane.

For the care of your crane and the prosperity of your business, ManitoWoc Crane Care is your single source for customer support. Wherever, whenever, whatever – we're there.

ManitoWoc Crane Care vereint alle Serviceleistungen von ManitoWoc im Produktsupport vor und nach dem Verkauf: Ersatzteile, Service, technische Dokumentation, technischer Support und Schulung, alles unter einem Dach. Dieser Service erstreckt sich auf alle Marken von ManitoWoc: Potain, Grove, ManitoWoc und National Crane.

Damit Ihr Kran leistungsfähig bleibt und Ihr Erfolg gesichert ist, bietet Ihnen ManitoWoc Crane Care einen umfassenden Support aus einer Hand. Zu jeder Zeit, an jedem Ort, für jeden Fall – wir sind für Sie da.

Organisation hors pair dédiée au support technique des produits de ManitoWoc, ManitoWoc Crane Care réunit au sein d'une même entité tous les aspects du service : pièces de rechange, service après-vente, publication technique, assistance technique et formation. Ce programme s'adresse à toutes les marques de ManitoWoc : Potain, Grove, ManitoWoc et National Crane.

Pour assurer l'entretien de vos grues et la prospérité de votre entreprise, ManitoWoc Crane Care constitue votre unique interlocuteur du service à la clientèle. Où que vous soyez, quel que soit votre besoin, vous pouvez toujours compter sur nous !

ManitoWoc Crane Care, es la organización post-venta y soporte técnico de ManitoWoc. ManitoWoc Crane Care combina todos los aspectos de piezas de repuesto, servicio, documentación técnica, apoyo técnico y formación en un único lugar. El programa también incluye todas las ramas ManitoWoc que engloba Potain, Grove, ManitoWoc y National Crane.

Para el cuidado de su grúa y la prosperidad de su negocio, ManitoWoc Crane Care, es la forma más sencilla de ayudarle. Donde sea y cuando sea, nosotros estamos allí.

ManitoWoc Crane Care è l'ineguagliabile organizzazione di supporto di ManitoWoc. ManitoWoc Crane Care gestisce tutte le attività legate a pezzi di ricambio, documentazione tecnica, assistenza tecnica e formazione riunite in un unico punto di riferimento. Questo servizio è attivo per tutti i marchi di ManitoWoc e precisamente Potain, Grove, ManitoWoc e National Crane.

Per l'assistenza delle Vostre gru e per la redditività dei Vostri investimenti, ManitoWoc Crane Care è l'insostituibile Vostra risorsa. In ogni posto, tutte le volte, per qualsiasi necessità – noi ci siamo.

Organização verdadeiramente ímpar do ManitoWoc Crane Group, é à ManitoWoc Crane Care que compete a responsabilidade pelo suporte técnico dos nossos produtos. Ela reúne, numa mesma entidade, todos os aspectos do serviço: peças de substituição, serviço pós-venda, documentação técnica, suporte técnico e formação. Este programa abrange todas as marcas do ManitoWoc Crane Group: Potain, Grove, ManitoWoc e National Crane.

Para assegurar a manutenção cuidada das suas gruas e a prosperidade do seu negócio, o seu único interlocutor do serviço de clientes é a ManitoWoc Crane CARE. Esteja onde estiver, sejam as horas que forem, precise do que precisar, pode sempre contar connosco!

ManitoWoc Crane Care - это не имеющая аналогов организация, входящая в ManitoWoc и осуществляющая техническую поддержку продукции. ManitoWoc Crane Care занимается всеми аспектами, связанными с запасными частями, услугами, технической документацией, технической поддержкой и обучением. Программа включает все торговые марки ManitoWoc, в том числе, Potain, Grove, ManitoWoc и National Crane.

ManitoWoc Crane Care является единой точкой контактов для всех клиентов компании, где они могут получить полное обслуживание для используемых ими кранов, что, в свою очередь, обеспечит процветание их бизнеса. Мы всегда там и в тот момент, где и когда мы необходимы.

**Dimensions • Abmessungen • Encombrement • Dimensiones  
• Dimensioni • Dimensões • Размеры**

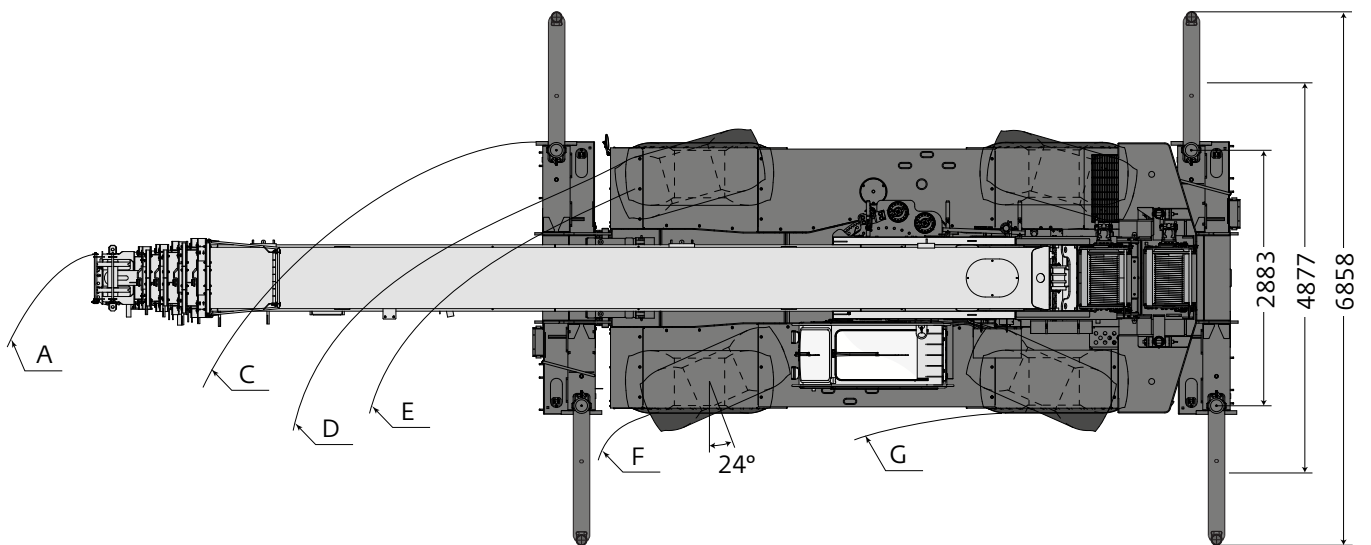
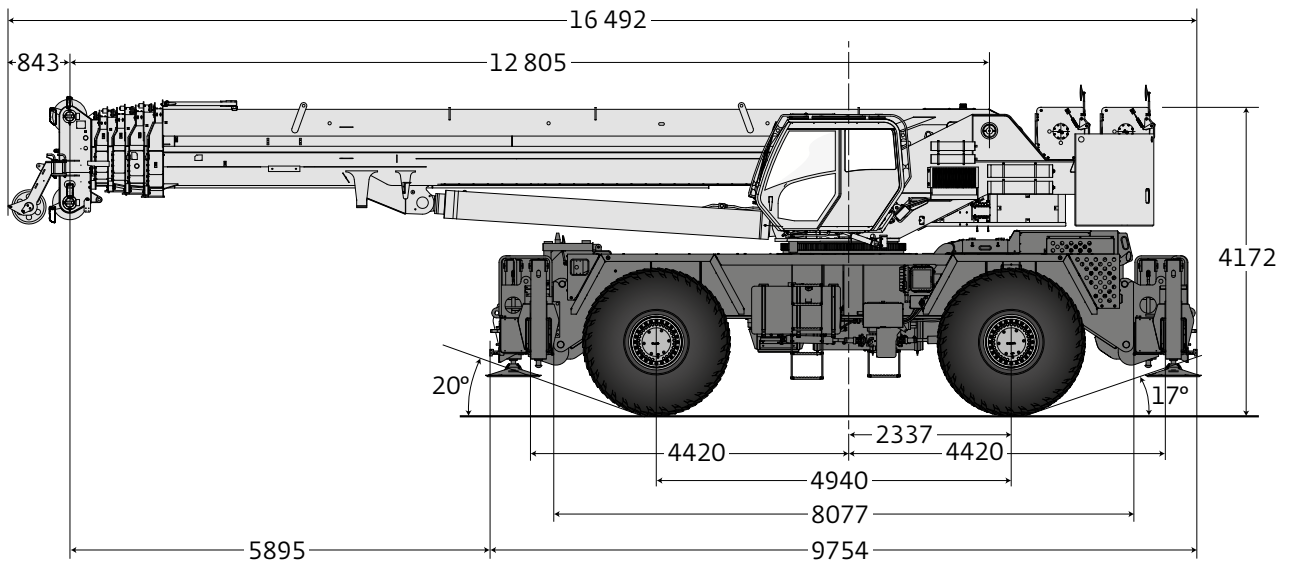

Tire size	A	C	D	E	F	G	A	B	C	D	E	F	G
33,25 x 29	18 237	15 748	14 884	14 453	11 709	10 236	13 970	14 453	10 973	10 135	9652	6909	5918
	2 wheel steer						4 wheel steer						

Note: Reference dimensions in mm • Hinweis: Bezugsmaße in mm • Remarque : cotes de référence en mm • Nota: Dimensiones de referencia en mm  
• Nota: Dimensioni di riferimento in mm • Nota: Dimensões de referência em mm • Примечание: Справочные размеры (в мм)



Axle Achse Essieu Eje Asse Eixo Оси	Total weight Gesamtgewicht Poids total Peso total Peso totale Peso total Суммарный вес	Front Vorne Avant Delantero Anteriore Dianteiro Передняя	Rear Hinten Arrière Trasero Posteriore Traseiro Задняя
	kg	kg	kg
<p>• Basic machine: includes 48,8 m main boom, main hoist with 290 m of wire rope and auxiliary hoist with 214 m of wire rope, manual offsettable bifold swingaway, full counterweight, 9 t headache ball, 82 t hook block • Grundauführung: umfasst einen 48,8 m langen Hauptausleger, ein Haupthubwerk mit einem 290 m langen Drahtseil und ein Hilfshubwerk mit einem 214 m langen Drahtseil, mechanisch verstellbare Doppelklappsitze, volles Gegen- gewicht, 9t Kugelhaken, 82t Hakenflasche • Machine de base : comporte une flèche principale de 48,8 m, un treuil principal avec 290 m de câble et un treuil auxiliaire avec 214 m de câble, une extension treillis double manuelle, un contrepoids complet, une boule de démolition de 9 t et un moufle à crochet de 82 t • Máquina básica: incluye pluma principal de 48,8 m, cabrestante principal con 290 m de cable y cabrestante auxiliar con 214 m de cable, plumín articulado en dos secciones, angulable manualmente, contrapeso completo, gancho de bola de 9 t, gancho de 82 t • Macchina base comprensiva di braccio principale da 48,8 m, argano principale con 290 m di fune metallica, argano ausiliario con 214 m di fune metallica, jib ripieghevole inclinabile manualmente, contrappeso completo, bozzello a palla da 9 t e bozzello da 82 t • Máquina base: inclui: lança principal de 48,8 m, guincho principal com 290 m de cabo, guincho auxiliar com 214 m de cabo, extensão dupla articulada(jib), manual, contrapeso completo, gancho de bola de 9 t e gancho de 82 t. • Основная машина: включает 48,8 м основной стрелы, основную лебедку с 290 м троса и вспомогательную лебедку с 214 м троса, ручной смещаемый двухсекционный вывод, полный противовес, 82-тонный крюкблок и 9-тонную шаровую бабу.</p>	79 460	36 275	43 186
<p>• Sub : Hydraulic offsettable bifold swingaway • Zusatz: Hydraulisch verstellbare Doppelklappsitze • Sub : Extension treillis double hydraulique • Con: plumín articulado en dos secciones, angulable hidráulicamente • Sub: jib ripieghevole inclinabile idraulicamente • Com: Extensão dupla articulada(jib), hidráulica • Подэлемент: гидравлический смещаемый двухсекционный вывод</p>	79 736	36 906	42 830
<p>Remove counterweight, aux. hoist and bifold swingaway • Gegengewicht, Hilfshubwerk und Doppelklappspitze abgebaut • Retirer le contrepoids, le treuil auxiliaire et l'extension treillis double • Retirando contrapeso, cabrestante auxiliar y plumín plegable • Rimuovere il contrappeso, l'argano ausiliario e il jib ripieghevole • Remover o contrapeso, o guincho auxiliar e a extensão dupla articulada(jib) • Без противовеса, всп. лебедки и складного удлинителя стрелы</p>	58 015	39 801	18 214
<p>Remove counterweight, aux. hoist and bifold swingaway, 72,5 t hook block, 9 t headache ball, and both outriggers boxes/beams • Gegengewicht, Hilfshubwerk und Doppelklappspitze, 72,5t Hakenflasche, 9t Kugelhaken und beide Abstützträger abgebaut • Retirer le contrepoids, le treuil aux. et l'extension treillis double, le moufle à crochet de 72,5 t, la boule de démolition de 9 t et les deux boîtiers/poutres de calage • Retirar el contrapeso, cabrestante auxiliar y el plumín articulado en dos secciones, el bloque de gancho de 72,5 t, la bola de servicio de 9 t, y las dos cajas estabilizadoras/vigas • Rimuovere contrappeso, argano ausiliario, jib ripieghevole, bozzello da 72,5 t, bozzello a palla da 9 t ed entrambe le casse degli stabilizzatori • Remover o contrapeso, o guincho auxiliar, a extensão dupla articulada(jib), o gancho de 72,5 t, o gancho de bola de 9 t e ambas as caixas dos estabilizadores • Снимите противовес, вспомогательную лебедку и двухсекционный вывод, 72,5-тонный крюкблок, 9-тонную шаровую бабу и обе лапы домкратов/балки опоры</p>	48 403	34 535	13 867
<p>Remove counterweight, aux. hoist and bifold swingaway, 72,5 t hook block, 9 t headache ball, both outriggers boxes/beams and boom assembly • Gegengewicht, Hilfshubwerk und Doppelklappspitze, 72,5t Hakenflasche, 9t Kugelhaken, beide Abstützträger und Ausleger abgebaut • Retirer le contrepoids, le treuil aux. et l'extension treillis double, le moufle à crochet de 72,5 t, la boule de démolition de 9 t, les deux boîtiers/poutres de calage et l'assemblage de flèche • Retirar el contrapeso, el cabrestante auxiliar y el plumín articulado en dos secciones, el bloque de gancho de 72,5 t, la bola de servicio de 9 t, las dos cajas estabilizadoras/vigas y el conjunto de la pluma • Rimuovere contrappeso, argano ausiliario, jib ripieghevole, bozzello da 72,5 t, bozzello a palla da 9 t, entrambe le casse degli stabilizzatori e il braccio completo • Remover o contrapeso, o guincho auxiliar, a extensão dupla articulada(jib), o gancho de 72,5 t, o gancho de bola de 9 t e ambas as caixas dos estabilizadores e a estrutura da lança • Снимите противовес, вспомогательную лебедку и двухсекционный вывод, 72,5-тонный крюкблок, 9-тонную шаровую бабу и обе лапы домкратов/балки опоры и блок стрелы</p>	33 202	14 191	19 011
<p>Remove counterweight, aux. hoist and bifold swingaway, 72,5 t hook block, 9 t headache ball, both outriggers boxes/beams, boom assembly and all tire/wheels • Gegengewicht, Hilfshubwerk und Doppelklappspitze, 72,5t Hakenflasche, 9t Kugelhaken, beide Abstützträger, Ausleger und alle Reifen/Räder abgebaut • Retirer le contrepoids, le treuil aux. et l'extension treillis double, le moufle à crochet de 72,5 t, la boule de démolition de 9 t, les deux boîtiers/poutres de calage, l'assemblage de flèche et les roues et pneus • Retirar el contrapeso, el cabrestante auxiliar y el plumín articulado en dos secciones, el bloque de gancho de 72,5 t, la bola de servicio de 9 t, las dos cajas estabilizadoras/vigas, el conjunto de la pluma y todas las unidades de neumático/rueda • Rimuovere contrappeso, argano ausiliario, jib ripieghevole, bozzello da 72,5 t, bozzello a palla da 9 t, entrambe le casse degli stabilizzatori, braccio completo e tutte le ruote • Remover o contrapeso, guincho auxiliar, a extensão dupla articulada(jib), o bloco do gancho 72,5 t, a estrutura da lança e todas as rodas/pneus • Снимите противовес, вспомогательную лебедку и двухсекционный вывод, 72,5-тонный крюкблок, 9-тонную шаровую бабу и обе лапы домкратов/ балки опоры, блок стрелы и все шины/колеса</p>	28 883	12 032	16 852



Lifting Capacity Traglast Force de levage Capacidad de elevación Capacità di sollevamento Capacidade de elevação Грузоподъемность	Sheaves Rollen Poulies Poleas Carrucolo Roldanas Шкивы	Parts of line Stränge Brins Ramales de cable Numero di funi Partes de cabo Кратность запасовки	Total weight Gesamtgewicht Poids total Peso total Peso totale Peso total Суммарный вес
120 t	8	2 to 16	1089 kg
9 t	H/B (swivel)	1	308 kg



	Infinitely variable Stufenlos Progressivement variable Infinitamente variable Infinitamente variabile Infinitamente variável Плавно-изменяемый	Rope Seil Câble Cable Fune Cabo Канат	Permissible line pull max. Max. Seilzug Effort maxi au brin Tracciones del cable admisibles Trazioni ammissibili della linea Esforço max. admissivel no cabo Максимально допустимое натяжение каната	Nominal cable length Seillänge (Nennwert) Longueur nominale des cables Longitud nominal del cable Lunghezza nominale cavo Comprimento nominal de cabo Номинальная длина каната
	0 - 171 m/min single line / bei einfachem Strang brin simple / ramal simple tiro a fune singola / cabo singelo Однократная запасовка	19 mm (18x19 class)	7620 kg	213 m
	0 - 171 m/min single line / bei einfachem Strang brin simple / ramal simple tiro a fune singola / cabo singelo Однократная запасовка	19 mm (6x37 class)	7620 kg	290 m
	0 - 2,5 min <sup>-1</sup>			
	20° 70° approx. 55 s ca. 55 s • env. 55 s aproximadamente 55 s circa 55 s • cerca de 55 s примерно 55 с			
	12,8 to 48,8 m approx. 232 s ca. 232 s • env. 232 s aproximadamente 232 s circa 232 s • cerca de 232 s примерно 232 с			

# Load charts • Traglasten • Capacités de levage • Capacidades Capacità • Diagramas de carga • Таблицы грузоподъемности

Working range • Arbeitsbereiche • Diagramme de levage • Gama de trabajo • Area di lavoro  
Intervalo de funcionamento • Грузовысотные характеристики



12,8 – 48,8 m



100 %



360°



18,1 t

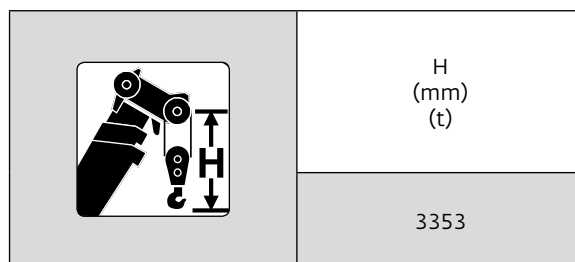
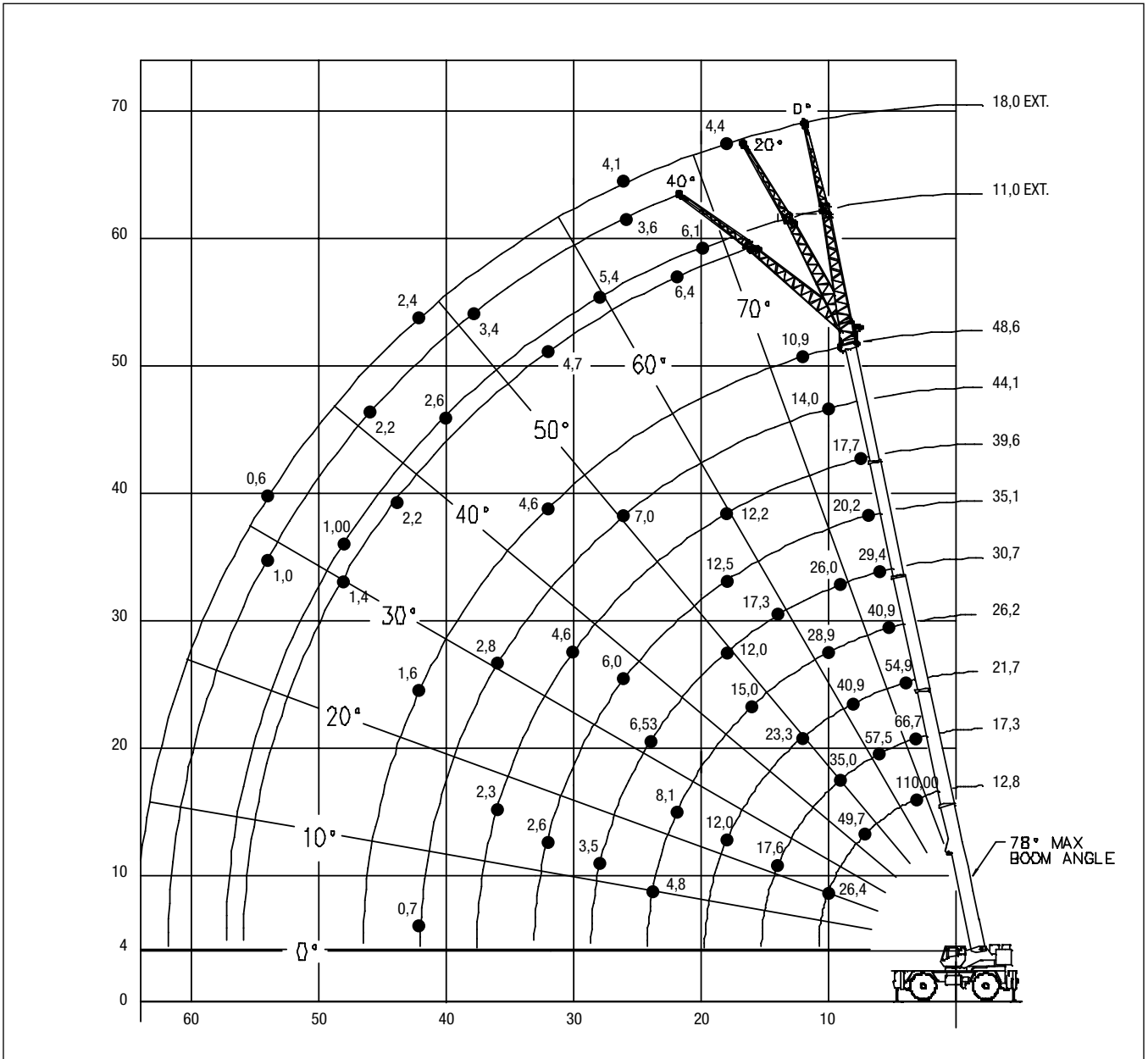



# Load charts • Traglasten • Capacités de levage • Capacidades Caracità • Diagramas de carga • Таблицы грузоподъемности

Telescopic boom • Teleskopausleger • Flèche principale • Pluma telescópica • Braccio telescopico  
Lança telescópica • Телескопическая стрела



12,8 - 48,8 m



100 %



360°



18,1 t



EN13000

m	12,8	17,3	21,7	26,2	30,7	35,1	39,6	44,1	48,8	m
3,0	110,000	66,675	-	-	-	-	-	-	-	3,0
3,5	104,500	66,675	-	-	-	-	-	-	-	3,5
4,0	92,900	66,675	54,900	-	-	-	-	-	-	4,0
4,5	81,525	66,675	54,200	-	-	-	-	-	-	4,5
5,0	72,975	63,925	53,500	40,900	-	-	-	-	-	5,0
6,0	59,200	57,525	52,175	39,425	29,450	-	-	-	-	6,0
7,0	49,700	48,850	46,950	37,200	28,725	20,225	-	-	-	7,0
8,0	41,825	41,025	40,925	34,600	27,750	20,225	-	-	-	8,0
9,0	35,750	35,000	34,900	31,500	26,000	20,225	17,750	-	-	9,0
10,0	26,400	30,475	30,375	28,925	24,025	20,225	17,400	14,000	-	10,0
12,0	-	23,400	23,350	23,475	20,300	18,950	16,675	13,525	10,950	12,0
14,0	-	17,600	18,450	18,650	17,300	16,625	15,250	13,050	10,625	14,0
16,0	-	-	14,825	15,050	14,675	14,375	13,725	12,475	10,150	16,0
18,0	-	-	11,975	12,200	12,075	12,475	12,175	11,375	9,780	18,0
20,0	-	-	-	9,980	9,865	10,625	10,675	10,275	9,380	20,0
22,0	-	-	-	8,155	8,050	8,900	9,330	9,090	8,370	22,0
24,0	-	-	-	4,815	6,530	7,395	7,930	7,970	7,340	24,0
26,0	-	-	-	-	5,230	6,095	6,750	6,985	6,450	26,0
28,0	-	-	-	-	3,475	4,875	5,660	6,025	5,780	28,0
30,0	-	-	-	-	-	3,845	4,620	5,120	5,275	30,0
32,0	-	-	-	-	-	2,585	3,730	4,235	4,630	32,0
34,0	-	-	-	-	-	-	2,955	3,455	3,935	34,0
36,0	-	-	-	-	-	-	2,280	2,775	3,260	36,0
38,0	-	-	-	-	-	-	-	2,175	2,655	38,0
40,0	-	-	-	-	-	-	-	1,645	2,120	40,0
42,0	-	-	-	-	-	-	-	0,690	1,640	42,0

AG-829-102217







85 %

m	12,8	17,3	21,7	26,2	30,7	35,1	39,6	44,1	48,8	m
3,0	120,000	66,675	-	-	-	-	-	-	-	3,0
3,5	105,750	66,675	-	-	-	-	-	-	-	3,5
4,0	92,900	66,675	57,600	-	-	-	-	-	-	4,0
4,5	81,525	66,675	57,600	-	-	-	-	-	-	4,5
5,0	72,975	63,925	56,125	42,000	-	-	-	-	-	5,0
6,0	59,200	57,525	52,700	39,425	29,475	-	-	-	-	6,0
7,0	49,700	48,850	46,950	37,200	28,850	20,225	-	-	-	7,0
8,0	41,825	41,025	40,925	34,600	27,750	20,225	-	-	-	8,0
9,0	35,750	35,000	34,900	31,500	26,000	20,225	19,575	-	-	9,0
10,0	26,400	30,475	30,375	28,925	24,025	20,225	19,325	14,750	-	10,0
12,0	-	23,400	23,350	23,475	20,300	18,950	17,475	14,750	11,375	12,0
14,0	-	17,600	18,450	18,650	17,300	16,625	15,250	14,500	11,200	14,0
16,0	-	-	14,825	15,050	14,675	14,375	13,725	12,750	11,000	16,0
18,0	-	-	11,975	12,200	12,075	12,475	12,175	11,375	10,575	18,0
20,0	-	-	-	9,980	9,865	10,625	10,675	10,275	9,460	20,0
22,0	-	-	-	8,155	8,050	8,900	9,330	9,090	8,370	22,0
24,0	-	-	-	4,815	6,530	7,395	7,930	7,970	7,340	24,0
26,0	-	-	-	-	5,230	6,095	6,750	6,985	6,450	26,0
28,0	-	-	-	-	3,475	5,020	5,660	6,025	5,780	28,0
30,0	-	-	-	-	-	4,065	4,720	5,165	5,275	30,0
32,0	-	-	-	-	-	2,585	3,915	4,415	4,630	32,0
34,0	-	-	-	-	-	-	3,165	3,680	3,960	34,0
36,0	-	-	-	-	-	-	2,510	3,035	3,415	36,0
38,0	-	-	-	-	-	-	-	2,455	2,870	38,0
40,0	-	-	-	-	-	-	-	1,800	2,335	40,0
42,0	-	-	-	-	-	-	-	0,690	1,865	42,0

AG-829-10216

# Load charts • Traglasten • Capacités de levage • Capacidades Capacità • Diagramas de carga • Таблицы грузоподъемности

Telescopic boom • Teleskopausleger • Flèche principale • Pluma telescópica • Braccio telescopico  
Lança telescópica • Телескопическая стрела

 12,8 - 48,8 m  100%  360°  10,9 t

  EN13000

m	12,8	17,3	21,7	26,2	30,7	35,1	39,6	44,1	48,8	m
3,0	110,000	66,675	-	-	-	-	-	-	-	3,0
3,5	99,050	66,675	-	-	-	-	-	-	-	3,5
4,0	86,675	66,675	54,900	-	-	-	-	-	-	4,0
4,5	75,975	66,675	54,200	-	-	-	-	-	-	4,5
5,0	68,000	62,650	53,500	40,900	-	-	-	-	-	5,0
6,0	54,625	53,225	52,175	39,425	29,450	-	-	-	-	6,0
7,0	45,575	44,725	44,650	37,200	28,725	20,225	-	-	-	7,0
8,0	38,125	37,350	37,225	34,600	27,750	20,225	-	-	-	8,0
9,0	32,475	31,750	31,650	31,475	26,000	20,225	17,750	-	-	9,0
10,0	24,875	27,550	27,475	27,650	24,025	20,225	17,400	14,000	-	10,0
12,0	-	21,000	20,950	21,125	20,300	18,950	16,675	13,525	10,950	12,0
14,0	-	15,900	16,400	16,600	16,475	16,625	15,250	13,050	10,625	14,0
16,0	-	-	12,925	12,925	12,875	13,725	13,725	12,475	10,150	16,0
18,0	-	-	9,850	9,900	9,800	10,675	11,400	11,375	9,780	18,0
20,0	-	-	-	7,575	7,495	8,350	9,190	9,630	9,380	20,0
22,0	-	-	-	5,765	5,700	6,540	7,355	7,855	8,200	22,0
24,0	-	-	-	4,325	4,235	5,095	5,895	6,380	6,725	24,0
26,0	-	-	-	-	3,045	3,900	4,700	5,175	5,520	26,0
28,0	-	-	-	-	2,050	2,895	3,710	4,175	4,520	28,0
30,0	-	-	-	-	-	2,045	2,850	3,325	3,670	30,0
32,0	-	-	-	-	-	1,315	2,110	2,600	2,950	32,0
34,0	-	-	-	-	-	-	1,475	1,955	2,320	34,0
36,0	-	-	-	-	-	-	0,915	1,390	1,765	36,0
38,0	-	-	-	-	-	-	-	0,895	1,270	38,0
40,0	-	-	-	-	-	-	-	-	0,830	40,0

AG-829-1-02217

  85%

m	12,8	17,3	21,7	26,2	30,7	35,1	39,6	44,1	48,8	m
3,0	115,000	66,675	-	-	-	-	-	-	-	3,0
3,5	99,050	66,675	-	-	-	-	-	-	-	3,5
4,0	86,675	66,675	57,600	-	-	-	-	-	-	4,0
4,5	75,975	66,675	57,600	-	-	-	-	-	-	4,5
5,0	68,000	62,650	56,125	42,000	-	-	-	-	-	5,0
6,0	54,625	53,225	52,700	39,425	29,475	-	-	-	-	6,0
7,0	45,575	44,725	44,650	37,200	28,850	20,225	-	-	-	7,0
8,0	38,125	37,350	37,225	34,600	27,750	20,225	-	-	-	8,0
9,0	32,475	31,750	31,650	31,475	26,000	20,225	19,575	-	-	9,0
10,0	24,875	27,550	27,475	27,650	24,025	20,225	19,325	14,750	-	10,0
12,0	-	21,000	20,950	21,125	20,300	18,950	17,475	14,750	11,375	12,0
14,0	-	15,900	16,400	16,600	16,475	16,625	15,250	14,500	11,200	14,0
16,0	-	-	13,050	13,250	13,125	14,000	13,725	12,750	11,000	16,0
18,0	-	-	10,400	10,625	10,500	11,350	11,975	11,375	10,575	18,0
20,0	-	-	-	8,540	8,430	9,290	9,950	10,250	9,460	20,0
22,0	-	-	-	6,855	6,750	7,615	8,270	8,795	8,370	22,0
24,0	-	-	-	4,645	5,305	6,150	6,855	7,375	7,340	24,0
26,0	-	-	-	-	4,035	4,880	5,665	6,150	6,445	26,0
28,0	-	-	-	-	2,920	3,810	4,630	5,085	5,415	28,0
30,0	-	-	-	-	-	2,910	3,720	4,185	4,520	30,0
32,0	-	-	-	-	-	2,135	2,935	3,410	3,750	32,0
34,0	-	-	-	-	-	-	2,255	2,725	3,085	34,0
36,0	-	-	-	-	-	-	1,665	2,130	2,495	36,0
38,0	-	-	-	-	-	-	-	1,600	1,965	38,0
40,0	-	-	-	-	-	-	-	1,130	1,500	40,0
42,0	-	-	-	-	-	-	-	0,670	1,080	42,0

AG-829-1-0216

# Load charts • Traglasten • Capacités de levage • Capacidades Caracità • Diagramas de carga • Таблицы грузоподъемности

Telescopic boom • Teleskopausleger • Flèche principale • Pluma telescópica • Braccio telescopico  
Lança telescópica • Телескопическая стрела



12,8 - 48,8 m



50 %



360°



18,1 t



EN13000 - 85 %

m	12,8	17,3	21,7	26,2	30,7	35,1	39,6	44,1	48,8	m
3,0	109,500	66,675	-	-	-	-	-	-	-	3,0
3,5	100,750	66,675	-	-	-	-	-	-	-	3,5
4,0	91,025	66,675	57,600	-	-	-	-	-	-	4,0
4,5	81,100	66,675	57,600	-	-	-	-	-	-	4,5
5,0	72,975	63,925	56,125	41,225	-	-	-	-	-	5,0
6,0	59,200	56,825	51,675	39,425	29,475	-	-	-	-	6,0
7,0	49,700	44,925	41,250	37,200	28,850	20,225	-	-	-	7,0
8,0	39,650	36,700	33,875	31,950	27,750	20,225	-	-	-	8,0
9,0	31,975	30,625	28,425	26,925	25,225	20,225	19,575	-	-	9,0
10,0	26,400	25,075	24,200	23,025	21,600	20,225	19,325	14,750	-	10,0
12,0	-	17,675	17,450	17,300	16,250	16,475	16,525	14,750	11,375	12,0
14,0	-	12,975	12,700	13,225	12,500	12,900	13,075	13,175	11,200	14,0
16,0	-	-	9,440	9,865	9,740	10,200	10,500	10,675	10,750	16,0
18,0	-	-	7,040	7,380	7,365	8,110	8,495	8,725	8,865	18,0
20,0	-	-	-	5,475	5,445	6,210	6,885	7,155	7,340	20,0
22,0	-	-	-	3,975	3,930	4,685	5,405	5,870	6,085	22,0
24,0	-	-	-	2,760	2,705	3,450	4,165	4,665	5,030	24,0
26,0	-	-	-	-	1,695	2,430	3,140	3,640	4,115	26,0
28,0	-	-	-	-	0,840	1,570	2,275	2,770	3,255	28,0
30,0	-	-	-	-	-	0,840	1,540	2,030	2,510	30,0
32,0	-	-	-	-	-	-	0,905	1,395	1,865	32,0
34,0	-	-	-	-	-	-	-	0,835	1,305	34,0
36,0	-	-	-	-	-	-	-	-	0,815	36,0

AG-829-102218



12,8 - 48,8 m



0 %



360°



10,9 t







EN13000 - 85 %

m	12,8	17,3	21,7	26,2	30,7	35,1	39,6	44,1	48,8	m
3,0	64,150	53,475	-	-	-	-	-	-	-	3,0
3,5	51,750	43,800	-	-	-	-	-	-	-	3,5
4,0	43,000	36,725	32,625	-	-	-	-	-	-	4,0
4,5	36,425	31,350	28,050	-	-	-	-	-	-	4,5
5,0	31,325	27,100	24,375	22,450	-	-	-	-	-	5,0
6,0	24,000	20,850	18,850	17,500	15,975	-	-	-	-	6,0
7,0	18,775	16,375	14,900	13,925	12,700	12,775	-	-	-	7,0
8,0	14,475	13,075	11,925	11,200	10,200	10,425	-	-	-	8,0
9,0	11,350	10,525	9,575	9,055	8,200	8,550	8,720	-	-	9,0
10,0	9,005	8,390	7,690	7,305	6,580	7,010	7,255	7,385	-	10,0
12,0	-	5,055	4,705	4,625	4,090	4,640	4,985	5,210	5,345	12,0
14,0	-	2,805	2,620	2,695	2,250	2,885	3,315	3,600	3,790	14,0
16,0	-	-	1,120	1,240	0,850	1,530	2,015	2,350	2,585	16,0
18,0	-	-	-	-	-	-	0,970	1,345	1,620	18,0
20,0	-	-	-	-	-	-	-	0,515	0,820	20,0

AG-829-102220

# Load charts • Traglasten • Capacités de levage • Capacidades Capacità • Diagramas de carga • Таблицы грузоподъемности

Telescopic boom • Teleskopausleger • Flèche principale • Pluma telescópica • Braccio telescopico  
Lança telescópica • Телескопическая стрела

 12,8 - 26,2 m  0 km/h  360°  10,9 t

  EN13000





m	12,8	17,3	21,7	26,2	m
3,0	28,000	-	-	-	3,0
3,5	28,000	-	-	-	3,5
4,0	25,600	-	-	-	4,0
4,5	22,600	-	-	-	4,5
5,0	20,075	15,675	-	-	5,0
6,0	15,950	15,425	10,300	8,255	6,0
7,0	11,800	11,625	10,300	8,255	7,0
8,0	8,910	8,840	7,880	7,850	8,0
9,0	6,760	6,700	5,690	6,130	9,0
10,0	5,105	5,005	4,100	4,720	10,0
12,0	-	2,495	1,935	2,560	12,0

AG-829-102260

  85 %

m	12,8	17,3	21,7	26,2	m
3,0	28,000	-	-	-	3,0
3,5	28,000	-	-	-	3,5
4,0	25,600	-	-	-	4,0
4,5	22,600	-	-	-	4,5
5,0	20,075	15,675	-	-	5,0
6,0	16,075	15,675	10,300	8,255	6,0
7,0	13,050	13,075	10,300	8,255	7,0
8,0	10,650	10,375	9,420	7,860	8,0
9,0	8,355	8,025	7,235	6,940	9,0
10,0	6,470	6,130	5,435	5,615	10,0
12,0	-	2,990	2,935	2,975	12,0

AG-829-102258

 12,8 - 26,2 m  4 km/h  0°  18,1 t

  EN13000 - 85 %

m	12,8	17,3	21,7	26,2	m
3,0	28,000	-	-	-	3,0
3,5	28,000	-	-	-	3,5
4,0	25,600	-	-	-	4,0
4,5	22,675	15,675	-	-	4,5
5,0	20,300	15,675	-	-	5,0
6,0	16,150	15,675	-	-	6,0
7,0	15,750	15,675	-	-	7,0
8,0	15,125	14,925	-	-	8,0
9,0	13,475	13,050	12,000	-	9,0
10,0	11,700	11,200	11,275	-	10,0
12,0	-	8,295	8,320	8,985	12,0
14,0	-	6,090	6,055	6,600	14,0
16,0	-	-	4,280	4,710	16,0
18,0	-	-	2,850	3,190	18,0
20,0	-	-	-	1,940	20,0
22,0	-	-	-	0,900	22,0

AG-829-102263

# Load charts • Traglasten • Capacités de levage • Capacidades Caracità • Diagramas de carga • Таблицы грузоподъемности

Swingaway • Klappspitze • Extension treillis • Plumín • Falcone • Jib • Складной удлинитель стрелы



12,8 - 48,8 m



11,0 - 33,8 m



100 %



360°



18,1 t



EN13000

m	11,0 m			18,0 m			m
	0°	20°	40°	0°	20°	40°	
14,0	6,520	-	-	-	-	-	14,0
16,0	6,380	-	-	4,360	-	-	16,0
18,0	6,240	6,425	-	4,360	-	-	18,0
20,0	6,105	6,285	6,560	4,295	-	-	20,0
22,0	5,970	6,150	6,430	4,235	4,375	-	22,0
24,0	5,830	6,015	6,175	4,170	4,290	-	24,0
26,0	5,640	5,830	5,810	4,110	4,190	3,635	26,0
28,0	5,445	5,500	5,460	4,045	4,090	3,580	28,0
30,0	4,980	5,155	5,150	3,960	4,000	3,530	30,0
32,0	4,405	4,650	4,735	3,855	3,910	3,485	32,0
34,0	3,870	4,105	4,270	3,750	3,830	3,445	34,0
36,0	3,405	3,625	3,775	3,470	3,655	3,410	36,0
38,0	2,985	3,195	3,330	3,065	3,355	3,380	38,0
40,0	2,600	2,795	2,915	2,690	3,020	3,195	40,0
42,0	2,170	2,435	2,540	2,355	2,665	2,865	42,0
44,0	1,745	2,070	2,195	2,050	2,340	2,535	44,0
46,0	1,355	1,645	1,805	1,770	2,035	2,210	46,0
48,0	1,005	1,260	1,410	1,500	1,765	1,915	48,0
50,0	0,685	0,910	-	1,160	1,505	1,630	50,0
52,0	-	0,585	-	0,845	1,245	1,355	52,0
54,0	-	-	-	0,555	0,925	1,000	54,0
56,0	-	-	-	-	0,625	-	56,0

AG-829-102241

m	25,9 m			33,8 m			m
	0°	20°	40°	0°	20°	40°	
18,0	2,870	-	-	-	-	-	18,0
20,0	2,870	-	-	-	-	-	20,0
22,0	2,820	-	-	1,540	-	-	22,0
24,0	2,770	2,995	-	1,540	-	-	24,0
26,0	2,720	2,945	-	1,535	-	-	26,0
28,0	2,670	2,895	2,900	1,495	1,655	-	28,0
30,0	2,620	2,845	2,900	1,455	1,610	-	30,0
32,0	2,560	2,780	2,900	1,415	1,570	1,705	32,0
34,0	2,500	2,720	2,890	1,375	1,530	1,675	34,0
36,0	2,440	2,660	2,840	1,335	1,485	1,650	36,0
38,0	2,380	2,600	2,705	1,300	1,445	1,620	38,0
40,0	2,315	2,540	2,550	1,260	1,405	1,595	40,0
42,0	2,095	2,410	2,405	1,210	1,360	1,565	42,0
44,0	1,795	2,135	2,240	1,160	1,320	1,540	44,0
46,0	1,515	1,835	2,055	1,110	1,280	1,510	46,0
48,0	1,265	1,565	1,770	1,025	1,235	1,480	48,0
50,0	1,035	1,315	1,495	0,800	1,125	1,305	50,0
52,0	0,815	1,075	1,235	-	0,890	1,095	52,0
54,0	0,620	0,860	1,000	-	-	0,865	54,0
56,0	-	0,660	0,775	-	-	-	56,0

AG-829-102250

# Load charts • Traglasten • Capacités de levage • Capacidades Capacità • Diagramas de carga • Таблицы грузоподъемности

Swingaway • Klappspitze • Extension treillis • Plumín • Falcone • Jib • Складной удлинитель стрелы



12,8 - 48,8 m



11,0 - 33,8 m



100 %



360°



18,1 t



85 %

m	11,0 m			18,0 m			m
	0°	20°	40°	0°	20°	40°	
14,0	7,255	-	-	-	-	-	14,0
16,0	7,235	-	-	4,580	-	-	16,0
18,0	7,190	7,120	-	4,580	-	-	18,0
20,0	7,160	7,080	6,865	4,580	-	-	20,0
22,0	6,985	6,665	6,560	4,580	4,555	-	22,0
24,0	6,525	6,245	6,175	4,580	4,555	-	24,0
26,0	6,080	5,855	5,810	4,580	4,550	3,895	26,0
28,0	5,620	5,500	5,460	4,580	4,445	3,835	28,0
30,0	4,980	5,155	5,150	4,460	4,315	3,780	30,0
32,0	4,405	4,650	4,735	4,210	4,105	3,730	32,0
34,0	3,870	4,105	4,270	3,910	3,870	3,660	34,0
36,0	3,405	3,625	3,775	3,470	3,655	3,530	36,0
38,0	2,985	3,195	3,330	3,065	3,355	3,385	38,0
40,0	2,600	2,795	2,915	2,690	3,020	3,195	40,0
42,0	2,260	2,435	2,540	2,355	2,665	2,865	42,0
44,0	1,930	2,110	2,195	2,050	2,340	2,535	44,0
46,0	1,605	1,795	1,865	1,770	2,035	2,210	46,0
48,0	1,260	1,460	1,500	1,515	1,765	1,915	48,0
50,0	0,940	1,125	-	1,265	1,505	1,630	50,0
52,0	0,600	0,600	-	1,015	1,260	1,365	52,0
54,0	-	-	-	0,745	1,015	1,115	54,0
56,0	-	-	-	-	0,745	-	56,0

AG-829-102240

m	25,9 m			33,8 m			m
	0°	20°	40°	0°	20°	40°	
18,0	3,205	-	-	-	-	-	18,0
20,0	3,205	-	-	-	-	-	20,0
22,0	3,205	-	-	1,995	-	-	22,0
24,0	3,205	2,995	-	1,995	-	-	24,0
26,0	3,205	2,995	-	1,995	-	-	26,0
28,0	3,205	2,995	2,900	1,995	1,915	-	28,0
30,0	3,205	2,995	2,900	1,995	1,915	-	30,0
32,0	3,205	2,995	2,900	1,995	1,915	1,810	32,0
34,0	3,160	2,985	2,890	1,995	1,915	1,810	34,0
36,0	2,960	2,950	2,840	1,995	1,915	1,810	36,0
38,0	2,705	2,805	2,705	1,995	1,915	1,810	38,0
40,0	2,420	2,615	2,550	1,960	1,915	1,810	40,0
42,0	2,095	2,410	2,405	1,790	1,890	1,810	42,0
44,0	1,795	2,135	2,240	1,545	1,775	1,725	44,0
46,0	1,515	1,835	2,055	1,270	1,600	1,600	46,0
48,0	1,265	1,565	1,770	1,025	1,360	1,480	48,0
50,0	1,035	1,315	1,495	0,800	1,125	1,305	50,0
52,0	0,815	1,075	1,235	-	0,890	1,095	52,0
54,0	0,620	0,860	1,000	-	-	0,865	54,0
56,0	-	0,660	0,775	-	-	-	56,0

AG-829-102247

# Load charts • Traglasten • Capacités de levage • Capacidades Caracità • Diagramas de carga • Таблицы грузоподъемности

Swingaway • Klappspitze • Extension treillis • Plumín • Falcone • Jib • Складной удлинитель стрелы



12,8 - 48,8 m



11,0 - 18,0 m



50 %



360°



18,1 t



EN13000 - 85 %

m	11,0 m			18,0 m			m
	0°	20°	40°	0°	20°	40°	
14,0	6,520	-	-	-	-	-	14,0
16,0	6,380	-	-	4,360	-	-	16,0
18,0	6,240	6,425	-	4,360	-	-	18,0
20,0	6,105	6,285	6,560	4,295	-	-	20,0
22,0	5,970	6,150	6,430	4,235	4,375	-	22,0
24,0	5,025	5,740	6,175	4,170	4,290	-	24,0
26,0	4,180	4,830	5,365	4,110	4,190	3,635	26,0
28,0	3,455	4,045	4,505	3,750	4,090	3,580	28,0
30,0	2,820	3,355	3,720	3,125	4,000	3,530	30,0
32,0	2,265	2,750	3,035	2,580	3,385	3,485	32,0
34,0	1,775	2,215	2,445	2,095	2,835	3,445	34,0
36,0	1,335	1,735	1,925	1,660	2,340	2,890	36,0
38,0	0,920	1,300	1,465	1,270	1,895	2,390	38,0
40,0	0,545	0,900	1,050	0,915	1,490	1,930	40,0
42,0	-	0,510	0,685	0,595	1,120	1,510	42,0
44,0	-	-	-	-	0,785	1,125	44,0
46,0	-	-	-	-	-	0,770	46,0

AG-829-10224A

# Load charts • Traglasten • Capacités de levage • Capacidades Capacità • Diagramas de carga • Таблицы грузоподъемности

Weight reductions • Gewichtsreduzierung durch Lastaufnahmemittel • Reductions de charge  
Reducciones de peso • Riduzioni di peso • Reduções de peso • Снижение веса

Auxiliary boom nose / Hilfsrollenkopf / Tête de flèche auxiliaire / Cabeza auxiliar / Falconcino ausiliario in testa al braccio / Cabeçote da lança auxiliar / Вспомогательный оголовок стрелы	54 kg
Hookblocks / Hakenflaschen / Moufles / Ganchos / Ganci / Cadernais / Крюковой блок	
118 tonne 8 sheave / Seilrollen / Réas / Poleas / Carrucole / Roldanas / блок	1089 kg
73 tonne 5 sheave / Seilrollen / Réas / Poleas / Carrucole / Roldanas / блок	725 kg
9,1 tonne overhaul ball / 9,1 t Kugelhaken / Crochet simple de 9,1 tonnes / Ganho de bola de 9,1 toneladas / Bozzello a palla da 9,1 tonnellate / Bola e gancho de 9,1 toneladas / 9,1-крюк с шаром утяжелителем	313 kg
10-18 m bifold swingaway fly jib / Doppelklappspitze / Extension de flèche repliable / Plumín Plegable / Prolunga ripiegabile del braccio / Extensão da lança articulada. / складной удлинитель стрелы	
11 m erected / Klappspitze vorgebaut / Déplié / Montado / Montato / Montado / смонтированный	2386 kg
18 m erected / Klappspitze vorgebaut / Déplié / Montado / Montato / Montado / смонтированный	4472 kg
25,9 m jib erected / Spitze vorgebaut / Déplié / Montado / Montato / Montado / смонтированный	6396 kg
33,8 m jib erected / Spitze vorgebaut / Déplié / Montado / Montato / Montado / смонтированный	8800 kg

Note: All load handling devices and boom attachments are considered part of the load and suitable allowances must be made for their combined weights.

Hinweis: Alle Lastaufnahmemittel und jede Zusatzausrüstung des Hauptauslegers werden als Teil der Traglast betrachtet und ihre kombinierten Gewichte müssen beim Feststellen der Nettolast entsprechend berücksichtigt (abgezogen) werden.

Remarque : Les équipements complémentaires et accessoires de levage sont considérés comme faisant partie de la charge ; les réductions de charges de leurs poids combinés doivent être effectuées.

Nota: Todos los aparos de elevación e implementos de pluma son considerados parte de la carga y deben ser tenidos en cuenta para calcular los pesos a elevar.

Nota: Tutti gli accessori di sollevamento e le opzioni montate sul braccio sono considerati parte del carico e devono essere richieste adeguate autorizzazioni per l'uso dei loro pesi complessive.

Nota: Todos os acessórios de elevação e opcionais de lança contribuem para a carga a elevar pelo que devem ser tidos em conta nos cálculos dos pesos a elevar

Примечание: Все погрузочно/разгрузочные устройства и дополнительные приспособления стрелы считаются частью нагрузки, поэтому в общем весе для них нужно учитывать некоторые допущения.



# Load charts • Traglasten • Capacités de levage • Capacidades de carga • Diagramas de carga • Таблицы грузоподъемности

Notes • Hinweise • Notes • Notas • Note • Notas • Примечания

## The lifting capacities correspond to DIN EN 13000:2014-11 and 85 %.

**Warning: THIS CHART IS ONLY A GUIDE. The Notes below are for illustration only and should not be relied upon to operate the crane. The individual crane's load chart, operating instructions and other instruction plates must be read and understood prior to operating the crane.**

The lifting capacities likewise fulfil the requirements of ISO 4305 and DIN 15019, Part 2, with regard to stability, and DIN 15018, Part 3, and FEM 5004 with regard to strength.

85%: Capacities are in accordance with SAE J1063 and do not exceed 85% of the tipping load (SAE J1289 for outriggers 50% and 0% extended) as determined by SAE J765.

1. Capacities given do not include the weight of hookblocks, slings, auxiliary lifting equipment and load handling devices. Their weights MUST be added to the load to be lifted. When more than minimum required reeving is used, the additional rope weight shall be considered part of the load.
2. All capacities are for crane on firm, level surface. It may be necessary to have structural supports under the outrigger floats or tyres to spread the load to a larger bearing surface.
3. When either boom length or radius or both are between values listed, the smallest load shown at either the next larger radius or boom length shall be used.
4. For outrigger operation, ALL outriggers shall be fully extended with tyres raised free of ground before raising the boom or lifting loads.
5. Tyres shall be inflated to the recommended pressure before lifting on rubber.

## Die Tragfähigkeiten entsprechen DIN EN 13000:2014-11 und 85 %.

**WARNUNG: DIESE TABELLE IST LEDIGLICHE EINE RICHTLINIE. Die Hinweise dienen als Erklärung und sind für die Kranbedienung nicht maßgebend. Vor Inbetriebnahme des Kranes sind Traglasttabellen, Bedienungsanleitung und andere Vorschriften eingehend zu studieren.**

Die Tragfähigkeitswerte erfüllen ebenfalls die Anforderungen von ISO 4305 und DIN 15019 Teil 2 bezüglich Standsicherheit sowie von DIN 15018 Teil 3 und FEM 5004 bezüglich Festigkeit.

85%: Tragkraftwerte entsprechen SAE J1063 und überschreiten nicht 85 % der Kipplast (SAE J1289 bei halb- bzw. ganz ausgefahrener Abstützung) gemäß Richtlinien SAE J765.

1. Das Gewicht der Hakenflaschen und aller Anschlagmittel muß zu der Last hinzugerechnet werden. Beim Einsetzen mit erhöhten Werten ist das zusätzliche Seilgewicht als Teil der Last zu betrachten.
2. Alle Werte gelten für den Kran auf festem, ebenem Untergrund. Eventuell müssen die Stützsteller oder Reifen unterlegt werden, um die Last über eine größere Abstützfläche zu verteilen.
3. Wenn Auslegerlänge oder Radius oder beide Werte zwischen den aufgeführten Werten liegen, ist die geringere der Traglasten zu wählen, ist die für den die nächstgrößere Ausladung oder die nächste bzw. anschließende Auslegerlänge genannt sind.
4. In abgestütztem Zustand müssen ALLE Stützen komplette ausgefahren sein. Die Reifen dürfen den Boden nicht berühren. Erst danach dürfen Lasten oder der Ausleger angehoben werden.
5. Bevor frei auf Rädern gearbeitet wird, müssen, die Reifen mit dem vorschriftsmäßigen Druck aufgefüllt werden.

## Les capacités de levage sont conformes à la norme DIN EN 13000:2014-11 et 85 %.

**ATTENTION: CE TABLEAU N'EST QU'UN GUIDE. Les notes ci-dessous sont données à titre d'exemple et ne devront pas être utilisées pour faire fonctionner la grue. Toute la documentation concernant chaque type de grue: tableau des charges, instructions de fonctionnement et toutes autres plaques d'instructions devront être lues et comprises avant de manoeuvrer la grue.**

Les capacités de levage respectent également les exigences des normes ISO 4305 et DIN 15019, paragraphe 2, relatives à la stabilité, ainsi que celles des normes DIN 15018 paragraphe 3 et FEM 5004 relatives à la résistance.

85% : Les capacités de levage sont conformes à la norme SAE J1063 et ne dépassent pas 85% de la charge de basculement (SAE J1289 pour les poutres de calage déployées à 50% et 0%) tel que cela est prescrit par la norme SAE J765.

1. Les charges mentionnées dans les tableaux ne comprennent pas le poids des moufles, des élingues et autres accessoires de levage qui doit être additionné à celui de la charge levée. Lorsque le mouflage est supérieur au minimum requis le poids de l'excédent de câble doit être additionné à celui de la charge.
2. Les capacités sont données sur sol ferme et de niveau. Il peut être nécessaire d'utiliser des bastingis ou des accessoires similaires afin de répartir la charge transmise au sol par les roues ou les patins de calage.
3. Lorsque la longueur de flèche ou la portée ne correspond pas aux valeurs mentionnées dans les tableaux, il convient de se référer à la valeur inférieure mentionnée pour la portée ou la longueur de flèche immédiatement supérieure.
4. Pour utilisation machine calée, les poutres de calage doivent être totalement télescopées et les roues décollées du sol avant de relever la flèche ou de lever des charges.
5. Les pneumatiques devront être gonflés aux pressions recommandées avant tout levage en libre.

## Las capacidades de carga corresponden a DIN EN 13000:2014-11 y 85 %.

**AVISO: ESTA TABLA ES SOLO UNA ORIENTACION. Las notas que aparecen al final de la misma solo sirven de ilustración y no deben ser tomadas como instrucciones para operar la grúa. La tabla de cargas, las instrucciones de operación y otras placas ilustrativas de cada grúa deben ser leídas y correctamente interpretadas antes de operar la grúa.**

Asimismo los valores de carga cumplen las disposiciones de las normas ISO 4305 y DIN 15019, 2.ª parte, respecto a la estabilidad, y DIN 15018, 3.ª parte, y FEM 5004 respecto a la fuerza.

85%: Le capacità di sollevamento sono conformi alla norma SAE J1063 e non superano l'85% del carico di ribaltamento (SAE J1289 per gli stabilizzatori estesi al 50% e 0%) come prescritto dalla norma SAE J765.

1. Las cargas indicadas no incluyen el peso de los ganchos, eslingas, equipos auxiliares y aparejos de elevación. Sus pesos DEBEN ser añadidos al de la carga a elevar. Cuando se utilice un número de ramales de cable superior al necesario, el peso adicional del cable debe ser considerado como parte de la carga.
2. Todas las capacidades corresponden a la grúa situada sobre terreno firme nivelado y uniforme. La naturaleza del terreno puede hacer necesario colocar, bajo los apoyos de los estabilizadores o bajo los neumáticos, elementos estructurales que repartan la carga sobre una mayor superficie de apoyo.
3. Cuando se trabaje con longitudes de pluma o rádios, intermedios entre los valores reflejados en las tablas, se considerará la carga inmediata inferior indicada en el radio o longitud de pluma inmediato superior.
4. Para trabajos sobre estabilizadores, TODOS los estabilizadores estarán totalmente extendidos y los neumáticos sin tocar el suelo antes de elevar pluma o izar cargas.
5. Los neumáticos deberán estar inflados a la presión recomendada antes de elevar cargas sobre neumáticos.

## Le tabelle di portata sono conformi alle norme DIN EN 13000:2014-11 e 85 %.

**ATTENZIONE: QUESTA TABELLA E' SOLO UNA GUIDA. Le note qui sotto riportate sono date a titolo d'esempio e non devono essere utilizzate per far funzionare la gru.**

**La tabella di carico, le istruzioni d'uso ed ogni altro foglio illustrativo devono essere letti e compresi prima di manovrare la gru.**

I valori delle tabelle di portata sono conformi anche ai requisiti delle norme ISO 4305 e DIN 15019, Parte 2, per quanto riguarda la stabilità, ed alle norme DIN 15018, Parte 3, e FEM 5004 per quanto riguarda il calcolo di resistenza della struttura.

85%: Capacidades de acuerdo con las Normas SAE J1063 y no exceden del 85% del momento de vuelco (Normas SAE J1289 para las cargas sobre estabilizadores extendidos al 50% o sin extender 0%) como fijan las normas SAE J765.

1. I carichi indicati nelle tavole non comprendono il peso dei ganci, dei tiranti, e di nessun altro accessorio di sollevamento che deve essere aggiunto a quello del carico sollevato. Quando il numero di funi è superiore al minimo richiesto il peso addizionale della fune deve essere aggiunto a quello del carico.
2. Tutte le capacità si intendono per la gru situata su un terreno compatto livellato e uniforme. Potrebbe rendersi necessario utilizzare dei supporti strutturali, sotto gli appoggi degli stabilizzatori o sotto i pneumatici, per ripartire il carico su una superficie di appoggio maggiore.
3. Quando la lunghezza del braccio o la portata non corrispondono ai valori riportati nelle tabelle, conviene considerare il valore inferiore riportato per il raggio di lavoro o la lunghezza del braccio immediatamente superiore.
4. Per lavoro su stabilizzatori, TUTTI gli stabilizzatori devono essere completamente estesi e i pneumatici staccati da terra prima di rialzare il braccio o di sollevare carichi.
5. I pneumatici devono essere gonfiati alla pressione raccomandata prima di sollevare carichi sopra i pneumatici.

## Capacidade de carga corresponde a DIN EN 13000:2014-11 e 85 %.

**Atenção: ESTE QUADRO SERVE APENAS DE GUIA. As notas abaixo são dadas a mero título exemplificativo e não deverão ser utilizadas para operar a grua. Toda a documentação e instruções relativas a cada tipo de grua, nas quais se incluem o diagrama de carga da grua, as respectivas instruções de operação e outras placas com instruções, têm de ser lidas e compreendidas antes de a grua ser operada.**

Capacidade de elevação também satisfazer os requisitos da norma ISO 4305 e DIN 15019, Parte 2, a estabilidade relativa, bem como os da DIN 15018 3 e GEF 5004 no que diz respeito à sua resistência.

85%: Le capacità di sollevamento sono conformi alla norma SAE J1063 e non superano l'85% del carico di ribaltamento (SAE J1289 per gli stabilizzatori estesi al 50% e 0%) come prescritto dalla norma SAE J765.

1. As capacidades indicadas não incluem o peso de cadernais, eslingas, equipamento auxiliar de elevação e dispositivos de manuseamento de cargas. Os seus pesos TEM de ser adicionados ao peso da carga a ser elevada. Sempre que for utilizada mais de que uma desmultiplicação de cabo, o peso adicional dos cabos deverá ser considerado parte da carga, devendo ser adicionado ao seu peso.
2. Todas as capacidades são indicadas para uma grua sobre uma superfície firme e nivelada. Pode ser necessário colocar suportes estruturais por baixo dos pneus ou das sapatas dos estabilizadores, para espalhar a carga por uma superfície de suporte maior.
3. Sempre que o comprimento da lança, o seu raio, ou ambos estiverem compreendidos entre os valores indicados, deve ser utilizada a carga mais baixa indicada para o raio ou para o comprimento de lança imediatamente superior.
4. Operação com estabilizadores: Antes de a lança ser erguida ou de serem elevadas cargas, TODOS os estabilizadores têm de estar totalmente estendidos, com os pneus erguidos de modo a não estarem em contacto com o solo.
5. Antes de serem elevadas cargas sobre os pneus, eles devem ser enchidos às pressões recomendadas.

## Грузоподъемность соответствует DIN EN 13000:2014-11 и 85 %.

**Внимание: ДАННАЯ СХЕМА ПРИВЕДЕНА ИСКЛЮЧИТЕЛЬНО В ОЗНАКОМИТЕЛЬНЫХ ЦЕЛЯХ. Нижеприведенные данные являются лишь пояснительными, на них не следует полагаться при работе с краном. Перед работой на кране следует прочесть и понять таблицы грузоподъемности, инструкцию по эксплуатации, а также инструктирующие таблички.**

Кроме того, грузоподъемность удовлетворяет требованиям ISO 4305 и DIN 15019 (часть 2) в отношении устойчивости, и DIN 15018, (часть 3), и FEM 5004 в отношении прочности материала.

85%: Нагрузка соответствует стандарту SAE J1063 и не превышает 85% от удерживающего момента (SAE J1289 для выносных опор, выдвигаемых на 50% и на 0%) в соответствии с SAE J765.

1. Указанная нагрузка не учитывает вес крюковых блоков, канатов, вспомогательного подъемного оборудования и погрузочно/разгрузочных устройств. Их вес СЛЕДУЕТ прибавлять к массе груза. При превышении минимально необходимой запасаки канатаследует учитывать его дополнительный вес.
2. Все нагрузки указаны для крана, находящегося на прочной плоской поверхности. С целью распределения нагрузки, под выносные опоры или под колеса можно подложить поддерживающие конструкции для увеличения площади опоры.
3. Если длина стрелы, вылет (или и то и другое) находятся между указанными значениями в таблице, следует брать наименьшую нагрузку, указанную за следующим значением радиуса или длины стрелы.
4. Перед подъемом стрелы или грузов (при использовании выносных опор) следует выдвинуть ВСЕ выносные опоры на полную длину, чтобы колеса оказались над землей.
5. При подъеме с колес, шины должны быть накачаны до рекомендуемого давления.

# Specification

## Superstructure



### Boom

12,8 m – 48,8 m, five section, sequenced synchronized full power boom. Maximum tip height: 51,5 m.



### Bifold swingaway extension

11,0 m - 18,0 m offsetable bifold lattice swingaway extension. Offsets 0°, 20° and 40°. Stows alongside base boom section. Maximum tip height: 69,2 m.



### \*Lattice Swingaway inserts

2 x 8 m lattice extension inserts. Installs between the boom nose and bifold extension, non-stowable. Maximum tip height: 85,0 m.



### Boom elevation

One double acting hydraulic cylinder with integral holding valve provides elevation from -3° to +78°.



### Load moment and anti-two block system

Standard "Graphic Display" load moment and anti-two block system with audio-visual warning and control lever lockout. These systems provide electronic display of boom angle, length, radius, tip height, relative load moment, maximum permissible load, load indication and warning of impending two-block condition. The standard Work Area Definition System allows the operator to pre-select and define safe working areas. If the crane approaches the pre-set limits, audio-visual warnings aid the operator in avoiding job-site obstructions.



### Cab

Full-vision, all-steel fabricated with acoustical lining and tinted safety glass throughout. Cab tilts to +20 degrees. Deluxe seat incorporates armrest-mounted hydraulic single-axis controllers. Dash panel incorporates gauges for all engine functions. Other standard features include: hot water heater, cab circulating air fan, air conditioning, sliding side and rear windows, sliding skylight with electric wiper and sunscreen, electric windshield wash/wipe, fire extinguisher and seat belt.



### Slewing

Two speed, planetary swing drive with foot applied multi-disc wet brake. Spring applied, hydraulically released swing brake. 360° positive swing lock and two position mechanical house lock, both operated from cab. Maximum speed: 2,5 RPM.



### Counterweight

18 144 kg. Hydraulically installed and removed.



### Hydraulic system

Six main pumps with a combined capacity of 776 LPM. Maximum operating pressure: 331 bar. Two individual post pressure compensated valve banks. Return line type filter with full flow by-pass protection and service indicator. Replaceable cartridge with micron filtration rating of 5/12/16. 1230 L hyd. reservoir. Remote mounted oil cooler with thermostatically controlled hydraulic driven motor, fan/air to oil. System pressure test ports.



### Hoist

Planetary reduction with automatic spring applied multi-disc wet brake. Grooved drum. Electronic hoist drum rotation indicators, and hoist drum cable followers. Maximum single line pull:

- 1st layer: 8 740 kg. • 3rd layer: 7 432 kg.
- 5th layer: 6 464 kg.

Maximum Permissible Line Pull: 7 620 kg with 6X37 class rope.  
7 620 kg. with 35X7 Rotation Resistant rope.

Maximum Single Line Speed: 171 m/min.  
Rope Construction: 6X36 EIPS IWRC, Special Flexible  
35x7 Flex-X, Rotation Resistant

Rope Diameter: 19mm.  
Rope Length: Main Hoist: 290 m - Auxiliary Hoist: 213 m.  
Maximum Rope Stowage: 368 m.



### CraneSTAR

Crane asset management system.

## Carrier



### Carrier frame

Box section frame fabricated from high-strength, low alloy steel. Removable outrigger housings, front/rear towing and tie down lugs.



### Outriggers

Four hydraulic telescoping single-stage double box beam outriggers with inverted jacks and integral holding valves. Three position setting, 0%, 50% and fully extended. Outrigger boxes removable for ease of transportation. All steel fabricated, quick release type outrigger floats, 775 mm diameter. Maximum outrigger pad load: 75 298 kg. Controls and crane level indicator located in cab.



### Engine

**Tier 3 / Euromot 3A:** Cummins QSC 8.3L diesel, six cylinders, 224 kW at 2200 rpm. Maximum torque: 1356 Nm at 1600 rpm.

Note: Required for sale outside of North America and European Union countries.

**Tier 4f / Euromot 4:** Cummins QSL 8.3L diesel, six-cylinder, turbo charged with Cummins diesel particulate exhaust filter/muffler. Meets U.S. E.P.A. Tier IV and E.U. Stage IIIB. 239 kW at 2200 rpm. Maximum torque: 1383 Nm at 1500 rpm. Fuel requirements: Maximum of 15 PPM sulphur content (Ultra Low Diesel Fuel) Note: Tier IV engine required in North America and European Union countries.

Fuel tank capacity: 379 l.



### Transmission

Sequential powershift with 6 forward and 3 reverse speeds. Front axle disconnect for 4 x 2 travel.



### Drive/Steer

4 x 4.

Fully independent power steering:

Front: Full hydraulic steering wheel controlled.

Rear: Full hydraulic switch controlled.

Provides infinite variations of 4 main steering modes: front only, rear only, crab and coordinated. Rear steer indicator.



### Axles

Front: Drive/steer with differential and planetary reduction hubs rigid mounted to frame.

Rear: Drive/steer with differential and planetary reduction hubs pivot mounted to frame.



### Tyres

Std. 33,25 X 29 - 38 bias ply, Titan.



### Brakes

Full hydraulic split circuit operating on all wheels. Spring-applied, hydraulically released parking brake mounted on front axle.



### Lights

Full lighting including turn indicators, head, tail, brake and hazard warning lights.



### Maximum speed

24 km/h.



### Gradeability (theoretical)

73% Based on 79 460 kg GVW, 33.25 x 29 tires, pumps engaged, 48,8 m boom, plus 18 m swingaway, 18 144 kg counterweight, hookblock and headache ball.



### Electrical system

Two 12 V - maintenance free batteries. 12 V starting and lighting, circuit breakers.

### \* Optional equipment

- Auxiliary lighting package (includes cab mounted amber flashing light, hoist mounted work light, single base boom mounted floodlights and rubber mat for stowage trough).
- Rear Pintle Hook
- Cab controlled cross axle differential locks, (front and rear)
- PAT event recorder down load kit
- Wind speed indicator (wireless)
- Hydraulic bi-fold swingaway
- Boom extension inserts
- CE mark conformance

\*Denotes optional equipment

## Kranoberwagen



### Ausleger

Fünfeiliger, voll teleskopierbarer Ausleger mit Synchronverstellung, 12,8 m bis 48,8 m. Maximale Hakenhöhe 51,5 m.



### Doppelklappspitze

Doppelklappspitze 11/18 m, mechanisch abwinkelbar (0°, 20°, 40°), am Auslegergrundkörper verstaubar. Maximale Hakenhöhe: 69,2m



### \*Zwischenstücke für Doppelklappspitze

Zwei (2) Zwischenstücke in Gitterbauweise, jeweils 8 m lang. Anbau zwischen Auslegerkopf und Doppel-Klappspitze, nicht verstaubar. Maximale Hakenhöhe: 85,0 m.



### Wippwerk

Ein doppelt wirkender Hydraulikzylinder mit integriertem Sicherheits-Rückschlagventil. Auslegerstellwinkel von -3° bis +78°.



### Lastmoment- und Hubendschalter-System

System für Lastmomentbegrenzung über Standard-„Grafikdisplay“ und Anti-Two Block System mit akustisch-optischer Warnung und Steuerhebelsperre. Diese Systeme bieten elektronische Anzeige von Auslegerwinkel, Auslegerlänge, Radius, Arbeitshöhe, relativem Lastmoment, maximal zulässiger Last, Hakenlast und Hubendschaltungs-Vorrichtung. Das zur Standardausrüstung gehörende System zur Arbeitsbereichsbegrenzung ermöglicht es dem Bediener, sichere Arbeitsbereiche vorzugeben und zu definieren. Nähert sich der Kran der Begrenzung des sicheren Arbeitsbereichs, wird der Bediener akustisch und optisch gewarnt, wodurch Kollisionen am Einsatzort vermieden werden.



### Kabine

**Rundumsichtkabine**, in Stahlblech ausgeführt, mit Schalldämmung und getöntem Sicherheitsglas. Kabine lässt sich um +20 Grad neigen. Komfortsitz mit in die Armlehnen integrierten, einachsigen verstellbaren Steuerhebeln. Armaturenbrett mit Anzeigen für alle Motorfunktionen. Weitere Standardausrüstung: Heißwasserheizung, Umluftgebläse, Schiebefenster seitlich und hinten, Dachschiebefenster mit elektrischem Scheibenwischer und Sonnenschutz, elektrischer Frontscheibenwischer/Waschanlage, Feuerlöscher und Sicherheitsgurt. Klimaanlage.



### Schwenkwerk

Zweistufiges Planetenschwenkwerk mit fußbetätigter Mehrscheiben-Ölbadbremse. Hydraulisch lösbare Federspeicher-Feststellbremse. 360° Schwenkwerkverriegelung und in zwei Stellungen festsetzbare Bolzenverriegelung, beide von der Kabine aus bedienbar. Max. Drehgeschwindigkeit: 2,5 RPM.



### Gegengewicht

Gegengewicht 18 144 kg, hydraulisch an- und abbaubar.



### Hydrauliksystem

Sechs Hauptpumpen mit einer Gesamtfördermenge von 776 l/Min. Maximaler Betriebsdruck: 331 bar. Zwei einzelne druckkompensierte Ventilblöcke. Filter mit Vollstrom-Bypassschutz und Wartungsanzeige im Rücklauf. Wechsellatrone mit einer Filtrationsleistung von 5/12/16. Fassungsvermögen des Hydrauliktanks: 1230 Liter. Abgesetzt montierter Ölkühler mit thermostatisch geregelter, vom Hydraulikmotor angetriebenem Lüfter/Luft-zu-Öl. Systemdruck-Prüfanschlüsse.



### Hubwerk

Planetengetriebe mit automatischer Federspeicher-Mehrscheibenbremse im Ölbad. Gerillte Seiltrommel. Elektronischer Hubwerksumdrehungs-Melder sowie Seilführungsbügel.

Maximaler Seilzug mit einfachem Strang:

- Erste Lage: 8 740 kg. • Dritte Lage: 7 432 kg.
- Fünfte Lage: 6 464 kg.

Maximal zulässiger Seilzug: 7 620 kg mit Seil Kategorie 6 x 37  
7 620 kg mit 35x7 Flex-X, drallfrei.

Maximale Seilgeschwindigkeit mit einfachem Strang: 171 m/Min.

Seilaufbau : 6X36 EIPS IWRC, besonders flexibel.

35x7 Flex-X, drallfrei..

Seildurchmesser: 19mm.

Seillänge: Haupthubwerk : 290 m. Hilfshubwerk : 213 m.

Hubwinde für max. 368 m Seil ausgelegt.



### CraneSTAR

Kran-Überwachungssystem

## Kranunterwagen



### Rahmen

Kastenprofilrahmen aus hochfestem Feinkornstahl. Abschlepp- und Verzurrösen vorne/hinten.



### Abstützungen

Vier hydraulisch teleskopierbare, einteilige Kastenprofil-Abstützträger mit innen geführten Stützzylindern und integrierten Halteventilen. Drei Stellungen: 0%, 50% und voll ausgefahren. Abnehmbare Abstützträger für einfachen Transport. Abstützteller mit Schnellentriegelung aus Stahl, Durchmesser 775 mm. Maximale Last auf den Abstütztellern: 75 298 kg. Bedienelemente und Nivellieranzeige in der Kabine.



### Motor

**Tier 3 / Euromot 3A:** Cummins QSC 8,3 L Dieselmotor, sechs Zylinder, Turbolader, 224 kW bei 2200 U/min. Maximales Drehmoment: 1356 Nm bei 1600 U/min. Hinweis: Zum Verkauf außerhalb Europas und Nordamerikas bestimmt.

**Tier 4f / Euromot 4:** Cummins QSL 8,3 L Dieselmotor, sechs Zylinder, mit Turbolader und Cummins-Dieselfußpartikelfilter. Entspricht Emissionsvorgaben nach U.S.E.P.A. Tier IV und E.U. Euromot Stufe III B. 239 kW bei 2200 U/min. Maximales Drehmoment: 1 383 Nm bei 1500 U/min. Treibstoffart: Maximal 15 ppm Schwefelanteil (besonders schwefelarmer Dieselkraftstoff). Hinweis: Diese Motoren sind zum Verkauf in Nordamerika und der Europäischen Union bestimmt. Kraftstoffbehälter: 379 l



### Getriebe

Powershiftautomatikgetriebe, 6 Vorwärtsgänge und 3 Rückwärtsgänge. Abkoppelung der Vorderachse für Fahrtrieb 4 x 2.



### Antrieb/Lenkung

4 x 4.

Separate Servolenkung :

Vorne : Vollhydraulisch, über Lenkrad betätigt.

Hinten : Vollhydraulisch, über Schalter betätigt.

Stellt vier stufenlos veränderliche Lenkarten bereit : Nur vorne, nur hinten, Hundegang und koordiniert. Lenkungsanzeige hinten. Wendekreis : 7,5 m.



### Achslinien

Vorne: Antrieb/Lenkung über Differenzial und Planetenuntersetzungsgetriebe, fest mit dem Rahmen verbunden.

Hinten: Antrieb/Lenkung über Differenzial und Planetenuntersetzungsgetriebe, pendelnd mit dem Rahmen verbunden.



### Bereifung

Standard 33,25 x 29 – 38-lagig, Diagonalreifen, Titan.



### Bremsen

Vollhydraulische Bremsen mit geteilten Bremskreisen, auf alle Räder wirkend. Hydraulisch lösbare Federspeicher-Feststellbremse, auf die Vorderachse wirkend.



### Beleuchtung

Volle Beleuchtungsanlage mit Blinkleuchten, Scheinwerfern, Schluss- und Bremsleuchten und Warnblinkanlage.



### Höchstgeschwindigkeit

24 km/h.



### Steigvermögen (theoretisch)

73 % (basierend auf: Bruttogewicht des Fahrzeuges 79 460 kg, Reifengröße 29,5 x 25, Pumpen aktiviert, Ausleger 48,8 m, Doppelklappspitze 18 m, gegengewicht 18 144 kg, Hilfshubwerk mit Seil und Hakenflasche).



### Elektrische Anlage

Zwei wartungsfreie 12-Volt-Batterien. 12-V-Anlasser und Beleuchtung, Sicherungsschalter.

### \* Zusatzausrüstung

- Zusatzbeleuchtung (einschl. kabinenmontierte Rundumleuchte, auf der Winde montiertes Arbeitslicht, am Ausleger-Basisstück montierte Flutlichter und Gummimatte für Staufach).
- Abschleppöse hinten.
- Differenzialsperren (vorne und hinten), von der Kabine aus zuschaltbar.
- PAT Datalogger.
- Windgeschwindigkeitsanzeige.
- Hydraulisch abwinkelbare Doppelklappspitze.
- Auslegerverlängerung • CE-zertifiziert

\*Kennzeichnet wahlweise Zusatzausrüstung

# Caractéristiques techniques

## Superstructure



### Flèche

12,8 m – 48,8 m. Flèche télescopique hydraulique, à cinq éléments, séquentielle et synchronisée. Hauteur maximale de tête de flèche : 51,5 m.



### Extension treillis

Extension treillis inclinable à double repliage latéral de 11,0 m à 18,0 m. Possibilité de déport à 0°, 20° et 40°. Repliage le long de l'élément de flèche de base. Hauteur max. de tête d'extension : 69,2 m.



### \*Extensions treillis à repliage latéral

2 éléments intermédiaires de 8 m pour extension treillis installés entre la tête de flèche principale et l'extension treillis double ; éléments transportés séparément. Hauteur max. d'extension treillis : 85,0 m.



### Relevage

Un vérin hydraulique double effet avec clapet anti-retour intégré. Angles de relevage -3° à +78°.



### Contrôleur d'état de charge et dispositif de fin de course haute crochet indépendant

En standard, contrôleur d'état de charge à affichage graphique et dispositif de course haute avec alarmes sonores et visuelles et dispositif de coupure des mouvements. Ces dispositifs donnent un affichage graphique de l'angle et de la longueur de flèche, de la portée, de la hauteur de tête de flèche, du moment relatif, de la charge maximum autorisée, de la charge levée et de sécurité de fin de course haute crochet. Le dispositif standard de limitation du domaine d'évolution (Work Area Definition System) permet à l'utilisateur de pré-définir et limiter le domaine de travail autorisé.



### Cabine

Cabine panoramique tout acier avec isolation sonore et vitrages de sécurité teintés, inclinable à 20°. Siège ergonomique équipé de manipulateurs multidirectionnels électriques doubles-axes intégrés aux accoudoirs. Tableau de bord équipé de tous les instruments nécessaires à la surveillance du moteur. Autres équipements montés en standard : colonne de direction réglable en inclinaison, chauffage de cabine à eau chaude, ventilateur, vitrages couvrants latéraux et arrière, vitre de toit coulissante équipée d'un essuie-glace et d'un rideau pare-soleil, essuie-glace et lave-glace de pare-brise, extincteur et ceinture de sécurité, air conditionné.



### Orientation

Réducteur d'orientation à planétaires, frein multi-disques immergés à commande au pied. Serrage par ressorts et desserrage hydraulique. Blocage d'orientation positive sur 360° et verrouillage mécanique d'orientation sur deux positions, le tout commandé depuis la cabine. Vitesse maximale : 2,5 tpm.



### Contrepoids

Contrepoids de 18 144 kg à mise en place et dépose hydraulique.



### Système hydraulique

Six pompes principales donnant un débit combiné de 776 litres/min. Pression maximum de service : 331 bars. Deux distributeurs hydrauliques indépendants avec compensateurs de pression. Filtre hydraulique sur circuit de retour avec protection par dérivation plein débit et indicateur de colmatage. Cartouche amovible avec classe de filtration micrométrique 5/12/16. Réservoir hydraulique de 1 230 litres. Refroidisseur air/huile, installé à distance, entraîné par moteur hydraulique à commande thermostatique. Prises de pressions rapides.



### Treuil

Entraînement par réducteur à planétaires et frein multi-disques immergés. Indicateurs électroniques de rotation du treuil et dispositif presse-câble. Efforts max. sur brin simple :

- 1<sup>ère</sup> couche : 8 740 kg.
- 3<sup>e</sup> couche : 7 432 kg.
- 5<sup>e</sup> couche : 6 464 kg.

Effort max. autorisé sur brin simple : 7 620 kg avec câble de classe 34x37.

Vitesse max. de déroulement : 171 m/min.

Câbles antigiratoires type 6 x 36 EIPS IWRC, Special Flexible ou 35x7 Flex-X.

Diamètre : 19 mm.

Longueur de câble : Treuil principal : 290 m et auxiliaire : 213 m

Capacité maximum de câble : 368 m



### CraneSTAR

Système de gestion de parc de grues

## Châssis



### Châssis

Châssis caissonné mécanosoudé en acier à haute limite élastique. Carters de dispositifs de calage amovibles, chapes de remorquage et d'arrimage à l'avant et à l'arrière.



### Dispositif de calage

Quatre poutres de calage hydrauliques télescopiques avec vérins inversés et clapets anti-retour intégrés. Calage autorisé en trois positions : 0 – 50% et 100%.

Systèmes de calage amovibles pour faciliter le transport. Patins d'appui en acier (775 mm de diamètre) avec dispositifs de fixation rapide. Charge maximum sur appui : 75 298 kg. Commandes de calage et indicateur de niveau dans la cabine.



### Moteur

**Tier 3 / Euromot 3A:** Diesel 6 cylindres Cummins QSC 8,3 L développant 224 kW à 2 200 tours/min. Couple maximum : 1356 Nm à 1600 tours/min. Note : Requis pour les ventes hors des pays d'Amérique du Nord et de l'Union européenne.

**Tier 4f / Euromot 4:** Diesel 6 cylindres turbocompressé Cummins QSL 8,3 L avec filtre/silencieux d'échappement à particules Cummins diesel. Respecte les exigences en matière d'émissions selon l'U.S.E.P.A. Tier IV et U.E. Phase III B. 239 kW à 2200 tr/min. Couple maximal : 1 383 Nm à 1500 tr/min. Exigences relatives au carburant : Maximum de 15 ppm de teneur en soufre (carburant diesel à très faible teneur). Note : Moteur Tier IV requis dans les pays d'Amérique du Nord et de l'Union européenne.

Capacité du réservoir : env. 379 l.



### Boîte de vitesse

Boîte de vitesses à 6 rapports avant et 3 rapports arrière. Débrayage de pont avant pour déplacement en 4 x 2.



### Direction/transmission

4 x 4.

Direction hydraulique indépendante :

Avant : Direction hydraulique indépendante actionnée par volant.

Arrière : Direction hydraulique indépendante commandée par interrupteur au tableau de bord.

Combinaisons infinies des quatre modes de direction : avant uniquement, arrière uniquement, marche en crabe et mode coordonné. Indicateur de direction arrière. Rayon de braquage : 7,5 m.



### Ponts

Avant : Pont moto-directeur avec différentiel et réductions à planétaires dans les moyeux fixé de manière rigide au châssis.

Arrière : Pont moto-directeur avec différentiel et réductions à planétaires dans les moyeux articulé au châssis



### Pneumatiques

Pneumatiques standard 33,25 x 29 à carcasse conventionnelle 38 plis, Titan.



### Freins

Freinage sur toutes les roues avec circuit scindé. Frein de stationnement à serrage par ressorts et desserrage hydraulique sur l'essieu avant.



### Eclairage

Eclairage complet incluant les clignotants, ainsi que les feux avant, arrière, de freinage et de détresse.



### Vitesse maximum

24 km/h.



### Aptitude théorique en pente

73% (calage du moteur) basé sur un véhicule d'un poids total de 79 460 kg, équipé de pneus 33,25 x 29, d'une flèche principale de 48,8 m, d'une extension à double repliage latéral manuel de 18,0 m, d'un contrepoids de 18 144 kg, d'un bloc de crochet et d'une boule de démolition de 9,0 t.



### Installation électrique

Deux batteries sans entretien de 12 Volts pour l'éclairage et le démarrage. Coupe circuit.

### \* Equipements optionnels

• Éclairage auxiliaire (inclut un gyrophare orange sur la cabine, un projecteur de travail sur le treuil, un projecteur installé sur la flèche de base et un tapis de caoutchouc pour le coffre de stockage) • Crochet de remorquage • Différentiels interroues commandés depuis la cabine (avant et arrière) • Enregistreur de données PAT data logger • Indicateur de vitesse du vent • Extension treillis à double repliage latéral hydraulique • Éléments intermédiaires pour extension de flèche • Conformité CE

\*Équipements optionnels

## Superestructura



### Pluma

Pluma sincronizada y totalmente hidráulica de cinco secciones, de 12,8 - 48,8 m. Altura máxima en punta al suelo : 51,5 m.



### Plumín de celosía

Plumín angulable de celosía articulado en dos secciones de 11,0 m - 18,0 m. Angulable 0°, 20° y 40°. Plegable junto al tramo base de la pluma. Altura máxima en punta: 69,2 m.



### \*Secciones insertadas de celosía abatibles

2 secciones de extensión de pluma de celosía de 8,0 m. Se instalan entre la cabeza de la pluma y el plumín de celosía, no se pueden plegar junto al tramo base de la pluma. Altura máxima en punta : 85,0 m.



### Elevación de pluma

Un cilindro hidráulico de doble efecto con válvula de retención integrada logrando elevación entre -3° y +78°.



### Sistema indicador del momento de carga y de final de carrera del gancho

Momento de carga estándar "con indicador gráfico" y sistema antibloqueo doble con señal de seguridad sonora y visual y bloqueo de la palanca de control. Estos sistemas proporcionan la visualización en una pantalla electrónica del ángulo, longitud, radio, altura de la punta al suelo, momento de carga relativo, carga máxima admisible, indicación de carga y aviso del estado del bloqueo doble inminente de la pluma. El sistema de definición del área de trabajo estándar permite al operario preseleccionar y definir zonas de trabajo seguras. Si la grúa se acerca a los límites predefinidos, una señal de aviso sonora y visual ayuda al operario a evitar obstrucciones en el lugar de la obra.



### Cabina

Cabina de visión panorámica, toda ella fabricada en acero con revestimiento acústico y cristal de seguridad tintado por completo. La cabina bascula hasta +20 grados. Asiento de lujo que incorpora los controles eléctricos de operación montados en reposabrazos. El panel de instrumentos incorpora indicadores para todas las funciones del motor. Forman parte del equipo de serie: volante regulable en altura, calefacción de agua, ventilador para la cabina, ventanillas laterales y traseras deslizantes, ventana superior abatible con limpia-parabrisas eléctrico y parasol, extintor y cinturón de seguridad. Aire acondicionado.



### Rotación

De dos velocidades, giro deslizante mediante planetarios con freno de discos múltiples accionado por pedal. Freno de giro accionado mediante resorte con desconexión hidráulica. Bloqueo de giro en los 360° y bloqueo interno mecánico de dos posiciones accionados desde la cabina. Velocidad máxima: 2,5 rpm.



### Contrapeso

18 144 kg. Instalado y desmontado hidráulicamente.



### Sistema hidráulico

Seis bombas principales con una capacidad combinada de 776 LPM. Presión de funcionamiento máxima: 331 bares. Dos bancos de válvulas de presión compensada. Filtro el el retorno con protección total ante derivaciones de flujo e indicador de mantenimiento. Cartucho reemplazable con una tasa de microfiltrado de 5/12/16. Depósito hidráulico de 1 230 l. Refrigerador separado de aceite con motor hidráulico controlado termostáticamente. Puertos de prueba de presión del sistema.



### Especificaciones del mecanismo de elevación principal y auxiliar

Reducción planetaria con freno automático de discos múltiples aplicado mediante resorte. Tambor acanalado con indicadores electrónicos de rotación del tambor.

Tensión máxima de un solo ramal de cable:

- Primera capa: 8 740 kg.      • Tercera capa: 7 432 kg.
- Quinta capa: 6 464 kg.

Tracción máxima admisible del cable: 7 620 kg con cable de clase 34x37.

7 620 kg con cable 35 x 7 antirrotación.

Velocidad máxima de un solo cable: 171 m/min

Estructura del cable : 6x36 EIPS IWRC, flexible especial  
35x7 Flex-X, antirrotación.

Diámetro del cable : 19 mm.

Longitud del cable : Cabrestante principal : 290 m y auxiliar : 213 m.

Capacidad máxima de cable en el tambor : 368 m.



### CraneSTAR

Sistema de gestión de flotas de grúas

RT9130E-2

## Chasis



### Bastidor

Estructura del chasis tipo cajón fabricada en acero de alta resistencia. Cajones de las vigas de los estabilizadores desmontables. Orejetas de amarre y gancho de arrastre.



### Estabilizadores

Cuatro estabilizadores hidráulicos telescópicos de doble viga con gatos invertidos y válvulas de retención integradas. Tres ajustes de posición: 0%, 50% y totalmente extendidos. Cajones de los estabilizadores extraíbles para facilitar el transporte. Placas base de los estabilizadores de accionamiento rápido, fabricadas completamente de acero de 775 mm de diámetro. Carga máxima sobre cada placa de apoyo de: 75.298 kg. Controles e indicador del nivel de la grúa situados en la cabina.



### Motor

Tier 3 / Euromot 3A: Cummins QSC 8,3 l diesel seis cilindros, 224 kW a 2 200 rpm. Par motor máximo: 1356 Nm a 1600 rpm. Nota: Necesario para la venta fuera de los países norteamericanos y de la Unión Europea.

Tier 4f / Euromot 4: Cummins QSL 8,3 l, seis cilindros y turbo. Con silenciador/filtro Cummins de tubo escape de partículas diésel. Cumple los estándares de emisiones Tier IV de la U.S.E.P.A. y Fase IIIB de la U.E. 239 kW a 2200 rpm. Par máximo: 1383 Nm a 1500 rpm. Exigencias de combustible: máximo de 15 ppm de contenido de azufre (diesel de muy bajo contenido en azufre). Nota: motor Tier IV necesario en los países norteamericanos y Unión Europea. Capacidad del depósito de combustible: 379 litros.



### Transmisión

Caja de cambios automática de 6 velocidades adelante y 3 atrás. Desconexión del eje frontal para un desplazamiento 4 x 2.



### Tracción/Dirección

4 x 4.

Dirección totalmente asistida independiente entre ejes :

Delantera : Totalmente hidráulica, controlada por volante.

Trasera : Totalmente hidráulica, controlada por interruptor.

Infinitamente variable en los 4 modos de dirección principales : sólo delantera, sólo trasera, control de giro (tipo cangrejo) y coordinada.

Indicador de dirección trasera. Radio de giro: 7,5 m.



### Ejes

Delantero : Tracción/dirección con reducción planetaria y diferencial, montaje rígido en la estructura.

Trasero : Tracción/dirección con reducción planetaria y diferencial, montaje pivotante en la estructura.



### Neumáticos

Estándar 33,25 x 29 - 38 lonas, Titan.



### Frenos

Circuito de frenos totalmente hidráulico operando sobre todas las ruedas. Freno de estacionamiento montado sobre el eje delantero que se acciona mediante resorte y se libera hidráulicamente.



### Luces

Iluminación completa que incluye intermitentes, indicadores superiores, traseros, de freno y de peligro.



### Velocidad máxima

24 km/h.



### Inclinación (teórica)

73% (durante el calado del motor) Basado en 79 460 kg de peso, neumáticos de 33,25 x 29, bombas dedicadas, pluma de 60,0 m, extensión abatible manual articulada en dos secciones de 18,0 m, contrapeso de 18 144 kg, bloque de gancho y bola de servicio.



### Sistema eléctrico

Dos baterías de 12V sin mantenimiento. Arranque e iluminación de 12V. Desconexión de la batería.

### \* Equipamiento opcional

• Equipo de iluminación auxiliar (incluye luz intermitente de color ámbar montada en la cabina, luz de trabajo montada en el cabrestante, focos montados en la pluma de una sola base y alfombrilla de goma para el hueco de almacenaje) • Gancho trasero con pasador de cadena • Bloqueos del diferencial de eje cruzado controlados desde la cabina (delanteros y traseros) • Registrador de datos PAT • Indicador de velocidad del viento • Extensión de celosía abatible articulada en dos secciones hidráulicamente angulable • Secciones insertadas de celosía • Marcado de conformidad CE

\*Indica equipo opcional.

# Caratteristiche tecniche

## Sovrastruttura



### Braccio

Braccio con sfilamento idraulico sequenziale - sincronizzato a cinque sezioni da 12,8 m a 48,8 m. Altezza massima in punta: 51,5 m.



### Jib telescopico ripiegabile

Falcone tralicciato inclinabile da 11,0 - 18,0 m. Inclinabile a 0°, 20° e 40°. Alloggiabile lungo la sezione del braccio. Altezza massima in punta: 69,2 m.



### \*Inserti di prolunga a traliccio

2 x 8 m sezioni intermedie tralicciate. Installabili tra la punta del braccio ed il falcone, non alloggiabili lungo il braccio. Altezza massima in punta: 85,0 m.



### Sollevamento braccio

Un cilindro idraulico a doppia azione con valvola di blocco integrale fornisce il sollevamento braccio con angolo da -3° a +78°.



### Limitatore di carico e finecorsa

Momento di carico standard con display grafico, sistema anti-doppio bloccaggio con allarme e bloccaggio dei movimenti. Visualizzazione grafica dell'angolo del braccio, lunghezza, raggio, altezza in punta, indicazione del carico e del carico ammissibile massimo. Il sistema standard di definizione dell'area di lavoro permette all'operatore di preselezionare e definire le aree di lavoro sicure. Se l'autogru si avvicina ai limiti preimpostati, degli allarmi acustici e visivi aiutano l'operatore ad evitare gli ostacoli sul posto di lavoro.



### Cabina

Ottima visibilità, costruita completamente in acciaio, insonorizzata. La cabina si inclina fino a +20°. Il sedile ergonomico è dotato di comandi elettrici a doppio asse integrati nei braccioli. Il cruscotto incorpora la strumentazione per tutte le funzioni del motore. Altre caratteristiche standard comprendono: volante inclinabile, riscaldamento ad acqua, ventola per la circolazione dell'aria nella cabina, finestrini scorrevoli, lava/tergicristallo elettrico, estintore e cintura di sicurezza. Aria condizionata.



### Rotazione

Comando di rotazione a due velocità, con riduttore planetario e freno idraulico a disco multiplo azionato a pedale. Freno di stazionamento a molla rilasciato idraulicamente. Bloccaggio meccanico della rotazione a 360° e con arresto meccanico in due posizioni, entrambi con azionamento dalla cabina. Velocità massima: 2,5 giri/minuto.



### Contrappeso

18 144 kg. Installato e rimosso idraulicamente.



### Impianto idraulico

Sei pompe principali con capacità totale di 776 l/min. Pressione operativa massima: 331 bar. Due valvole singole di controllo a pressione compensata. Filtro sulla linea di ritorno non bypassabile e indicatore di manutenzione. Cartuccia sostituibile con valore di filtraggio micronico di 5/12/16. Capacità del serbatoio idraulico 1230 l. Scambiatore di calore dell'olio indipendente, con motore idraulico comandato da termostato. Prese per la misura della pressione del sistema.



### Specifiche dell'organo principale e ausiliario

Riduttore planetario e freno negativo multidisco ad azionamento automatico. Tamburo scanalato. Indicatore elettronico di rotazione del tamburo sul joystick e guide per cavo tamburo organo.

Tiro massimo con singola fune:

- Primo strato: 8 740 kg. • Terzo strato: 7 432 kg.
- Quinto strato: 6 464 kg.

Tiro massimo permesso sulla fune: 7 620 kg con fune di classe 6X37.  
7 620 kg con fune di classe 35X7, resistente alla rotazione.

Velocità massima con singola fune : 171 m/min.

Costituzione della fune: 6 x 36 EIPS IWRC, flessibilità speciale  
35x7 Flex-X, resistente alla rotazione.

Diametro fune : 19 mm.

Lunghezza della fune : sull'organo principale : 290 m e ausiliario : 213 m

Massima capacità di avvolgimento della fune sul tamburo : 368 m.



### CraneSTAR

Sistema di gestione della flotta gru.

## Carro



### Telaio

Costruito con sezioni realizzate in acciaio ad alta resistenza. Alloggiamenti degli stabilizzatori rimovibili. Punto di fissaggio per traino anteriore e posteriore.



### Stabilizzatori

Quattro stabilizzatori ad azionamento idraulico e cilindri a stelo rovesciato, valvole di blocco integrali. Impostazione a tre posizioni, 0%, 50% e completamente estesi. Casse degli stabilizzatori rimovibili per agevolare il trasporto. Costruzione completamente in acciaio, piatti stabilizzatori a rilascio rapido, diametro 775 mm. Carico massimo piatti stabilizzatori: 75 298 kg. Comandi e indicatore di livello della gru situati all'interno della cabina.



### Motore

**Tier 3 / Euromot 3A:** Diesel Cummins QSB da 8,3 l, 6 cilindri, 224 kW (lordi) a 2200 giri al minuto. Coppia max : 1356 Nm a 1600 giri al minuto. Nota: richiesti per vendita al di fuori dei paesi del Nord America e dell'Unione Europea.

**Tier 4f / Euromot 4:** Cummins QSL 8,3 L diesel, sei cilindri, sovralimentato con turbocompressore, con sistema di post-trattamento costituito dal filtro antiparticolato Cummins DPE, 239 kW a 2200 giri/min. Coppia massima: 1383 Nm a 1500 giri/min. Conforme ai requisiti richiesti per le emissioni secondo E.P.A. (United States) Tier IV e EUROMOT (Comunità Europea) Stadio 3B. Carburante richiesto: diesel con contenuto massimo di zolfo 15 ppm (Ultra Low Diesel Fuel). Nota: il motore Tier IV / Euromot 3B è richiesto nei paesi del Nord America e dell'Unione Europea.

Capacità serbatoio: 379 l



### Cambio

Con 6 marce avanti e 3 retromarcia.

Scollegamento assale anteriore per marcia 4 x 2.



### Trazione/Sterzo

4 x 4.

Idroguida completamente indipendente:

Anteriore : completamente idraulico azionato tramite il volante.

Posteriore : completamente idraulico azionato con interruttore.

Fornisce 4 modalità di sterzata: solo anteriore, solo posteriore, a granchio e combinata. Indicatore di allineamento delle ruote posteriori.

Raggio di sterzo : 7,5 m.



### Assali

Anteriore : Montato rigido sul telaio, trazione con differenziale e mozzini di riduzione planetaria.

Posteriore : Su culla oscillante, trazione con differenziale e mozzini di riduzione planetaria montati.



### Pneumatici

Standard 33,25 x 29 - 38 strati trasversali, Titan.



### Freni

Doppio circuito completamente idraulico agente su tutte le ruote.

Freno di stazionamento negativo ad azionamento idraulico agente sull'asse anteriore.



### Luci

Illuminazione completa compresi indicatori di direzione, luci anteriori, posteriori, freno e luci di segnalazione pericolo.



### Velocità massima

24 km/h.



### Pendenza (teorica)

73% calcolato su peso lordo di 79 460 kg, pneumatici 33,25 x 29, falcone ripiegabile meccanico da 18,0 m, contrappeso da 18 144 kg, bozzello e gancio a palla.



### Impianto elettrico

2 batterie da 12 V. Avviamento e illuminazione a 12 V.

Interruttore di disconnessione.

### \* Equipaggiamenti opzionali

• Pacchetto di illuminazione ausiliario (comprende luci lampeggianti ambra montate in cabina, luce di lavoro montata sull'organo, e proiettori montati su braccio a base doppia.) • Gancio del rimorchio posteriore • Bloccaggio differenziali trasversali controllati dalla cabina (anteriore e posteriore) • Registratore di dati PAT • Indicatore della velocità del vento • Prolunga del braccio rotante a traliccio disassiale idraulicamente • Inserti di prolunga a traliccio • Marcatura di conformità CE

\*Indica attrezzature opzionali

## Superestrutura

### Lanca

Lanca de cinco secções, de telescopagem hidráulica, sincronizada. Comprimento total de 12,8 a 48,8 m. Altura máxima da ponta da lanca : 51,5 m

### Extensão swingaway fixa

Extensão swingaway treliçada de dobragem dupla, 11,0 m - 18,0 m. Angulações: 0°, 20° e 40°. Pode ser arrumada ao longo da secção de base da lanca. Altura máx. da cabeça da extensão: 69,2 m.

### \*Inserções swingaway treliçadas

2 extensões de 8,0 m da estrutura. Instalam-se entre a ponta da lanca e a extensão bipartida, não acondicionáveis. Altura máx. da cabeça da extensão: 85,0 m.

### Elevação da lanca

Um cilindro hidráulico de acção dupla com válvula anti-retorno integral assegura a elevação de -3° a +78°.

### Sistema de momento de carga e fim de curso do cadernal

“Indicador gráfico” standard do momento de carga e do sistema de fim de curso do cadernal com sistema audiovisual de sinalização e dispositivo de bloqueio automático das alavancas de comando. Estes sistemas fornecem informações, apresentadas em visor electrónico, do ângulo da lanca, do comprimento, do raio, da altura da ponta da lanca, do momento de carga relativo, da carga máxima admitida, da indicação de carga e aviso sobre o fim de curso do cadernal. O Sistema de Definição da Área de Trabalho standard permite ao operador seleccionar previamente e definir áreas de trabalho. Se a grua se estiver a aproximar dos limites previamente definidos, avisos audiovisuais ajudam o operador a evitar obstruções no local da obra.

### Cabine

Cabine panorâmica, integralmente feita de aço, com isolamento sonoro e vidro de segurança colorido a toda a volta. Cabine inclinável até +20 graus. O assento Deluxe integra controladores de eixo duplo, eléctricos, instalados no apoio para os braços. O painel de controlo está equipado com manómetros para todas as funções do motor. Entre as demais funcionalidades standard incluem-se: Volante inclinável, aquecedor da cabine de água quente, ventoinha de circulação do ar na cabine, janelas lateral e traseira deslizantes, vidro de tejadilho deslizante com limpa-vidros eléctrico e pala para o sol, lava e limpa pára-brisa eléctricos, extintor de incêndios e cinto de segurança. Ar condicionado.

### Rotação

Accionamento da rotação de planetários de duas velocidades com travão em banho de óleo tipo multidisco de aplicação com o pé. Travão de imobilização de mola e de libertação hidráulica. Bloqueio de rotação positiva de 360° e dispositivo de bloqueio mecânico de duas posições, ambos accionados a partir da cabine. Velocidade máxima : 2,5 rpm.

### Contrapeso

18 144 kg. Instalado e desmontado por meios hidráulicos.

### Sistema hidráulico

Seis bombas principais com uma capacidade combinada de 776 LPM. Pressão de serviço máxima: 331 bar. Dois conjuntos individuais de válvulas de pressão compensada. Filtro no circuito de retorno com protecção por derivação de débito total e indicador de manutenção. Cartucho substituível com classe de filtragem micrométrica de 5/12/16. Depósito de 1230 L. Radiador de óleo montado à distância com motor hidráulico controlado por termostato, ventoinha/ar para óleo. Tomadas para teste de pressão do sistema.

### Guincho

Redutor de planetários com travão em banho de óleo multidiscos de mola, automático. Indicadores electrónicos da rotação do tambor de elevação e acamador de cabo no tambor de elevação. Esforço máximo no cabo singelo:

- Primeira camada: 8 740 kg.
- Terceira camada: 7 432 kg.
- Quinta camada: 6 464 kg.

Esforço máximo admitido no cabo singelo: 7 620 kg com cabo da classe 6x37.  
7 620 kg com cabo da classe 35x7 resistente à rotação.

Velocidade máxima do cabo singelo : 171 m/min.

Tipo de Cabo: 6x37 EIPS IWRC, flexível especial. 35x7 Flex-X resistente à rotação.

Diâmetro do Cabo: 19 mm.

Comprimento do cabo: Guincho principal : 290 m e auxiliar : 213 m. Capacidade

Máxima do Cabo : 368 m.

### CraneSTAR

Sistema de gestão de frotas de guas.

RT9130E-2

## Chassis

### Chassis

Estrutura do chassis tipo caixa fabricado em aço de alta resistência. Caixas dos estabilizadores dianteiros e traseiros removíveis, engates para reboque dianteiro e traseiro e olhas para elevação.

### Estabilizadores

Quatro vigas de estabilização hidráulicas e telescópicas, de caixa dupla, de secção simples, com macacos invertidos e válvulas anti-retorno integrais. Três posições : 0%, 50% e totalmente estendidas. Caixas do estabilizador amovíveis para facilitar o transporte. Todos os estabilizadores de remoção rápida fabricados em aço, diâmetro de 775 mm. Carga máxima dos estabilizadores: 75 298 kg. Controlos e indicador de nível da grua localizados na cabina.

### Motor

**Tier 3 / Euromot 3A:** Cummins QSB 8,3 L diesel, seis cilindros, turboalimentado, 224 KW a 2.200 rpm. Binário máximo: 1356 Nm a 1600 rpm. Nota: Necessário para venda nos países fora da América do Norte e da União Europeia

**Tier 4f / Euromot 4:** Cummins QSL 8,3 L diesel, seis cilindros, turboalimentado, com silenciador/filtro de partículas diesel Cummins. Respeita os níveis de emissões de acordo com Tier IV da U.S.E.P.A. e classe IIIB da U.E. 239 KW a 2.200 rpm. Binário máximo: 1383 Nm a 1500 rpm. Requisitos relativos ao combustível: máximo de 15 ppm de teor de enxofre (diesel de muito baixo teor em enxofre). Nota: o motor Tier IV é necessário para venda nos países da América do Norte e da União Europeia. Depósito de 379 l.

### Transmissão

Transmissão Powershift integral com 6 velocidades de marcha à frente e 3 velocidades de marcha-atrás. Desembraiagem do eixo frontal para deslocação 4 x 2.

### Tracção/direcção

4 x 4.

Direcção assistida de comando independente:

À frente : totalmente hidráulica, comandada pelo volante.

Àtrás : totalmente hidráulica, comandada por interruptor.

Disponibiliza um número infinito de variações dos 4 principais modos

de direcção: só dianteira, só traseira, direcção tipo caranguejo e direcção coordenada.

Indicador de direcção traseira. Raio de viragem : 7,5 m.

### Eixos

Dianteiros : Eixo de tracção/direcção com cubos do reductor de planetários e diferencial rigidamente montados no chassis.

Traseiros : Eixo de tracção/direcção com cubos do reductor de planetários e diferencial montados no chassis de forma articulada (pivôs).

### Pneus

Pneus standard 33,25 x 29 - 38 telas, Titan.

### Travões

Travões de circuito dividido, totalmente hidráulicos, que actuam sobre todas as rodas. Travão de estacionamento de mola e de libertação hidráulica, montada no eixo dianteiro.

### Iluminação

Conjunto completo, incluindo luzes de sinalização de mudança de direcção, faróis dianteiros, faróis traseiros, luzes de travagem e luzes de sinalização de perigo.

### Velocidade máxima

24 km/h.

### Gradabilidade (teórica)

73% (paragem do motor) baseado em PB 79 460 kg, pneus 33.25 x 29, lanca principal de 48,8 m, extensão dupla articulada manual de 18,0 m, 18 144 kg de contrapeso, gancho e gancho de bola.

### Sistema eléctrico

Duas baterias de 12 V que dispensam manutenção. Arranque e luzes de 12 V. Interruptor de desconexão da bateria.

### \* Equipamento opcional

• Pacote de iluminação auxiliar (inclui pirlampo rotativo montada na cabine, luz de trabalho montada no guincho, um foco montado no tramo base da lanca e protecção em borracha da zona de armazenagem • Gancho de reboque traseiro • Bloqueios do diferencial do eixo cruzado controlados na cabine (dianteiros e traseiros) • Registo de dados • PAT • Indicador de velocidade do vento • Extensão dupla treliçada(jib) hidráulica • Inserções swingaway treliçadas • Conformidadecom a Marca CE

\*Assinala o equipamento opcional

# Технические характеристики

## Крановая установка



### Стрела

Пятисекционная, полноприводная, телескопическая стрела длиной 12,8 – 48,8 м. Максимальная высота оголовка стрелы: 51,5 м.



### Фиксированный удлинитель стрелы

Складной решетчатый удлинитель стрелы длиной 11,0 / 18,0 м. Возможность установки под углом в 0°, 20° или 40°. Складывается вдоль секции основной стрелы. Максимальная высота оголовка удлинителя: 69,2 м.



### \*Решетчатые удлиняющие вставки

2 решетчатых вставки длиной 8 м. Устанавливаются между оголовком стрелы и складным удлинителем. Не складываются. Максимальная высота оголовка удлинителя стрелы: 85,0 м.



### Угол наклона стрелы

Один гидравлический цилиндр двойного действия со встроенным обратным клапаном обеспечивает подъем от -3° до +78°.



### Ограничитель грузовой нагрузки и ограничитель высоты подъема крюка

Стандартный ограничитель грузовой нагрузки с графическим дисплеем и система блокировки при переподъеме с звуковой и визуальной сигнализацией и блокировкой органов управления. Эти системы выводят на электронный дисплей угол наклона стрелы, длину, радиус, высоту оголовка стрелы, относительный грузовой момент, максимально допустимую нагрузку, текущую нагрузку и предупреждение о возможности перегруза. Стандартная система ограничения рабочей зоны позволяет оператору заранее выбрать и определить безопасные рабочие зоны. При приближении крана к установленным границам срабатывает звуковая и визуальная сигнализация предупреждения оператора.



### Кабина

Полностью стальная кабина с круговым обзором, звукоизоляцией и тонированными небьющимися стеклами по всему периметру. Наклон кабины до +20 градусов. Высококачественное сиденье оборудовано встроенными в подлокотники органами управления с одноосевым перемещением. Контрольные приборы для всех рабочих функций выведены на приборную панель. Остальные опции, включенные в стандартную поставку: обогреватель на горячей воде, вентилятор, раздвижные боковые и задние стекла, раздвижная застекленная крыша с электрическим стеклоочистителем и солнцезащитным экраном, электроомыватель и очиститель лобового стекла, огнетушитель и ремень безопасности. Воздушный кондиционер.



### Поворот

Двухскоростной привод с планетарным редуктором, охлаждаемый жидкостью тормоз системы управляемый педалью из кабины машиниста. Пружинный гидравлически освобождаемый тормоз механизма, фиксатор поворота, двухпозиционная блокировка поворота крановой установки, оба с управлением из кабины. Максимальная скорость: 2,5 об/мин.



### Противовес

18 144 кг. Гидравлическая система монтажа.



### Гидравлическая система

Шесть главных насосов с общей производительностью 776 л/мин. Максимальное рабочее давление: 331 бар. Две независимых группы клапанов. Фильтр возвратной магистрали с полнопоточной обходной защитой и индикатором обслуживания. Сменный картридж, минимальный размер частиц, удаляемых фильтром - 5/12/16. Бак на 1230 л. Выносной масляный радиатор с термостатом и вентиляторным охлаждением с приводом от гидравлического мотора. Контрольные отверстия для проверки давления системы.



### Лебедка подъема

Планетарный редуктор с автоматическим пружинным многодисковым жидкоохлаждаемым тормозом. Желобчатый барабан. Электронные индикаторы вращения подъемного барабана и кабельные держатели.

Максимальное натяжение каната при однократной заповке:  
• 1 слой: 8 740 кг. • 3 слой: 7 432 кг. • 5 слой: 6 464 кг.  
Максимально допустимое натяжение каната: 7620 кг с канатом класса 6X37. 7620 кг с устойчивым к скручиванию канатом 35X7.

Максимальная скорость каната при однострунной оснастке: 171 м/мин.  
Контрукция каната: 6X36 с сердечником из высокопрочной стали для подъемных канатов особой гибкости, высокого качества.  
35x7 Flex-X, устойчивый к скручиванию

Диаметр каната: 19 мм.  
Длина каната: Лебедка основного подъема: 290 м - Лебедка вспомогательного подъема: 213 м.  
Максимальная длина укладки каната: 368 м



### CraneSTAR

Система управления ресурсом крана.

## Тягач



### Шасси

Коробчатая рама выполнена из высокопрочной низколегированной стали. Съёмные кожухи выносных опор, передние/задние буксировочные и крепежные проушины.



### Выносные опоры

Четыре гидравлические телескопические одноступенчатые двухмуфтовые балочные выносные опоры с перевернутыми цилиндрами и встроенными блокирующими клапанами. 3 позиции выдвижения: 0%, 50% и на полную длину. Блоки выносных опор, съёмные, для упрощения транспортировки. Стальные, легко доступные опорные подушки диаметром 775 мм. Максимальная нагрузка на подушку выносной опоры: 75 298 кг. Органы управления и указатель уровня крана расположены в кабине.



### Двигатель

Дизельный, 6-цилиндровый двигатель Cummins QSB объемом 8,3 л, мощностью 300 лс, 224 кВт (полная мощность) на 2 200 об/мин. Максимальный крутящий момент: 1356 Нм при 1600 об/мин.



### Трансмиссия

Коробка переключения передач с 6 передними и 3 задними скоростями. Отключение переднего моста для передвижения в режиме 4 х 2.



### Ведущие/управляемые колеса

4 х 4.

Полностью независимое рулевое управление с усилителем. Передние: С полным гидравлическим усилением. Управление от рулевого колеса.

Задние: С полным гидравлическим усилением. Ручное управление с помощью переключателей.

Возможны многочисленные варианты 4 основных режимов рулевого управления: только передние, только задние, крабовый ход и согласованный режим. Индикатор заднего движения. Радиус разворота: 7,5 м.



### Оси

Передняя: Ведущая с управляемыми колесами, с дифференциальными и планетарными колесными редукторами, жестко смонтированными на раму. Задняя: Ведущая с управляемыми колесами, с дифференциальными и планетарными колесными редукторами, шарнирно закрепленными на раму.



### Шины

Станд. 33,25 х 29 - 38 с диагональным кордом, общего применения.



### Тормоза

Полностью гидравлические, раздельные на все колеса. Пружинный, гидравлически отпускаемый парковочный тормоз, закрепленный на передней оси.



### Фары

Полное освещение, включая индикаторы поворота, передние, задние, тормозные фонари и лампы аварийной сигнализации.



### Максимальная скорость

24 км/ч.



### Электросистема

Две, не требующие обслуживания, батареи на 12 В. Напряжение запуска и освещения - 12 В. Отключение батарей.

### \* Дополнительное оборудование (по выбору)

































- Дополнительный осветительный комплект (состоит из установленного на кабине осветительного фонаря ночного освещения, установленного на подъемнике рабочего освещения, установленных на стреле прожекторов на одиночной основе, а также резиновых коврик).
- Задний поворотный буксирный крюк.
- Механизм блокировки межколесного дифференциала, (передний и задний).
- Регистратор данных РАТ.
- Индикатор скорости ветра.
- Двусторонний складной решетчатый удлинитель стрелы с гидравлическим управлением.
- Решетчатые удлиняющие вставки.
- Соответствие нормам Евросоюза.

\*Дополнительное оборудование



# Notes • Hinweise • Notes • Notas • Note • Примечания

## Symbols • Symbolerklärung • Glossaire des symboles • Glosario de simbolos • Glossario dei simboli • Simbolos • Символы

	Axles Achsen Ponts Ejes Assali Оси		Counterweight Gegengewicht Contrepoids Contrapeso Contrappeso Противовес		Main hoist Haupthubwerk Treuil principal Cabrestante principal Argano principale Лебедка основного подъема		Outriggers Abstützung Calage Estabilizadores Stabilizzatori Выносные опоры
	Axle load Achslast Charge à l'essieu Carga por eje Carico sugli assi Нагрузка на ось		Crane functions Kranbewegungen Mouvements de la grue Funciones de la grúa Funzioni della gru Функции крана		Auxiliary hoist Hilfshubwerk Treuil auxiliaire Cabrestante auxiliar Argano secondario Лебедка вспомогательного подъема		Radius Ausladung Portée Radio Raggio Вылет
	Boom Ausleger Flèche Pluma Braccio Стрела		Crane travel Fahrstellung Déplacement de la grue Grúa en traslado Traslazione gru Перемещение крана		Hookblock / Capacity Hakenflasche / Traglast Moufle / Force de levage Gancio / Capacità Gancio / Capacità Крюковой блок / Грузоподъемность		Slewing/Working range Drehwerk/Arbeitsbereich Orientation/Rayon d'opération Giro/Gama de trabajo Rotazione/Area di lavoro Поворот/ Рабочий диапазон
	Boom elevation Wippwerk Relevage Elevación de pluma Elevazione braccio Подъем стрелы		Drive/Steer Antrieb/Lenkung Direction/Déplacement Tracción/Dirección Trazione/Sterzo Ведущие/Управляемые оси		Hydraulic system Hydrauliksystem Circuit hydraulique Sistema hidráulico Impianto idraulico Гидравлическая система		Speed Geschwindigkeit Vitesse Velocidad Velocità Скорость
	Boom telescoping Teleskopieren Télescopage de flèche Telescopaje de pluma Lunghezza braccio Выдвижение стрелы		Electrical system Elektrische Anlage Circuit électrique Sistema eléctrico Impianto elettrico Электросистема		Lattice extension Gitterspitze Extension treillis Extensión de celosía Falcone tralicciato Гусек		Suspension Federung Suspension Suspensión Sospensioni Подвеска
	Brakes Bremsen Freins Frenos Freni Тормоза		Engine Motor Moteur Motor Motore Двигатель		Lattice extension (luffing) Gitterspitze (wippbar) Extension treillis (volée variable) Extensión de celosía (angulable hidráulicamente) Falcone tralicciato (inclinabile) Гусек (с изменением вылета)		Transmission / Gear Getriebe / Gang Boîte de vitesses / Rapport Transmisión / Cambio Trasmissione / Cambio Трансмиссия / передача
	Cab Kabine Cabine Cabina Cabina Кабина		Free on wheels Freistehend Sur pneus Sobre neumáticos Su gomma Свободные внутренние колеса		Luffing jib Wippspitzenausleger Volée variable Plumín angulable Falcone a volata variabile Маневровый гусек		Travel speed Fahrtgeschwindigkeit Vitesse de déplacement Velocidad de desplazamiento Velocità di traslazione Скорость движения
	Carrier frame Chassis-Rahmen Châssis porteur Bastidor Telaio Рама тягача		Gradeability Steigfähigkeit Aptitude en pente Superación de pendientes Pendenza superabile Преодолеваемый уклон		Low range Kriechgang Gamme basse Marchas cortas Fuoristrada Низкий диапазон		Tyres Bereifung Pneumatiques Neumáticos Pneumatici Шины

## Manitowoc Cranes

### Regional headquarters

#### Americas

Manitowoc, Wisconsin, USA

Tel: +1 920 684 6621

Fax: +1 920 683 6277

Shady Grove, Pennsylvania, USA

Tel: +1 717 597 8121

Fax: +1 717 597 4062

#### Europe, Middle East, Africa

Dardilly, France

Tel: +33 (0)4 72 18 20 20

Fax: +33 (0)4 72 18 20 00

#### China

Shanghai, China

Tel: +86 21 6457 0066

Fax: +86 21 6457 4955

#### Greater Asia-Pacific

Singapore

Tel: +65 6264 1188

Fax: +65 6862 4040

### Regional offices

#### Americas

##### Brazil

Alphaville

##### Mexico

Monterrey

##### Chile

Santiago

#### Europe, Middle East, Africa

##### France

Baudemont

Cergy

Decines

##### Germany

Langenfeld

##### Italy

Lainate

##### Netherlands

Breda

##### Poland

Warsaw

##### Portugal

Baltar

##### Russia

Moscow

##### South Africa

Johannesburg

##### U.A.E.

Dubai

##### U.K.

Buckingham

#### China

Beijing

Chengdu

Guangzhou

Xian

#### Greater Asia-Pacific

##### Australia

Brisbane

Melbourne

Sydney

##### India

Chennai

Delhi

Hyderabad

Pune

##### Korea

Seoul

##### Philippines

Makati City

##### Singapore

### Factories

#### Brazil

Passo Fundo

#### China

TaiAn

Zhangjiagang

#### France

Charlieu

Moulins

#### Germany

Wilhelmshaven

#### India

Pune

#### Italy

Niella Tanaro

#### Portugal

Baltar

Fânzeres

#### USA

Manitowoc

Port Washington

Shady Grove

This document is non-contractual. Constant improvement and engineering progress make it necessary that we reserve the right to make specification, equipment, and price changes without notice. Illustrations shown may include optional equipment and accessories and may not include all standard equipment.

Die Angaben in diesem Dokument erfolgen ohne Gewähr. Wir verbessern unsere Produkte ständig und integrieren den technischen Fortschritt. Aus diesem Grund behalten wir uns das Recht vor, die technischen Daten, die Ausstattungsdetails und die Preise unserer Maschinen ohne Vorankündigung zu ändern.

Ce document est non-contractuel. Du fait de sa politique d'amélioration constante de ses produits liée au progrès technique, la Société se réserve le droit de procéder sans préavis à des changements de spécifications, d'équipement ou de prix. Les illustrations peuvent comporter des équipements ou accessoires optionnels ou ne pas comporter des équipements standards.

Este documento no es contractual. El perfeccionamiento constante y el avance tecnológico hacen necesario que la empresa se reserve el derecho de efectuar cambios en las especificaciones, equipo y precios sin previo aviso. En las ilustraciones se puede incluir equipo y accesorios opcionales y es posible que no se muestre el equipo normal.

Documento non contrattuale. In considerazione della sua politica di costante miglioramento dei prodotti connesso al progresso tecnico, la Società si riserva il diritto di modificare senza preavviso specifiche, equipaggiamenti o prezzi. Le illustrazioni possono contenere equipaggiamenti o accessori optional o non contenere equipaggiamenti standard.

Este documento não se reveste de qualquer carácter contratual. A introdução constante de melhorias e o progresso da engenharia tornam necessário reservarmos o direito de introduzir alterações nas características técnicas, no equipamento e no preço sem qualquer aviso prévio. As ilustrações aqui apresentadas podem incluir equipamento e acessórios adicionais, podendo não incluir todo o equipamento padrão.

Данный документ не является контрактным. Принимая во внимание необходимость постоянного совершенствования и модернизации мы оставляем за собой право изменять спецификации, конструкции и стоимость без предварительного уведомления. Приведенные иллюстрации могут содержать дополнительные компоненты и принадлежности, не входящие в стандартный комплект поставки оборудования.